



STRUC  since 1573
Kovačija Muta



MADE IN SLOVENIA

STRUC Kovačija Muta d.o.o.
since 1573

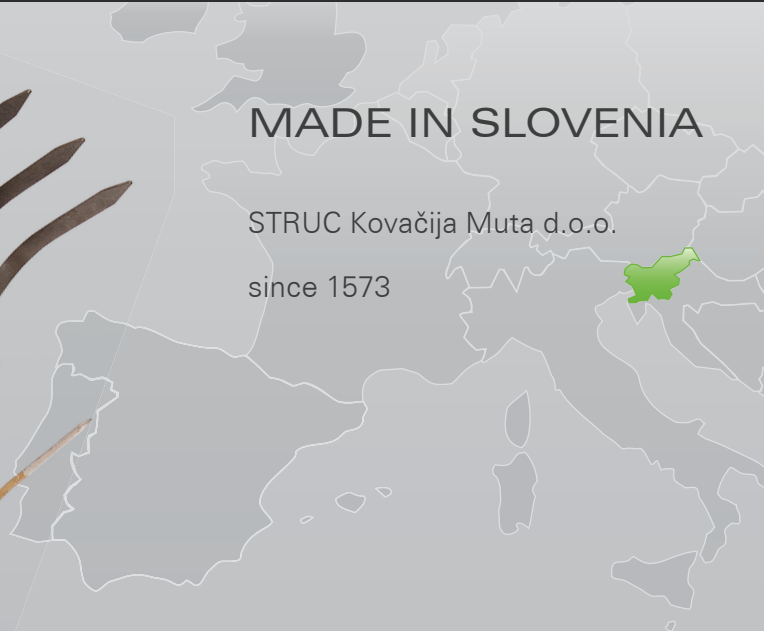

A close-up, artistic photograph of a typewriter's internal mechanism. The focus is on the carriage and the typebars, which are arranged in a dense, repeating pattern. The lighting is dramatic, highlighting the metallic surfaces and the intricate details of the machine. The background is blurred, emphasizing the foreground components.

TRADICIJA STOLETIJ
JAHRHUNDERTLANGE TRADITION
CENTURIES OF TRADITION

TRADICIJA KOVAŠTVA OD 1573
UPORABA KAKOVOSTNIH MATERIALOV
ZAVEZA H KVALITETI, KI VZBUJA ZAUPANJE

STRUC Kovačija d.o.o.

Naše glavno področje je proizvodnja kmetijskega, gradbenega in vrtnega orodja kot tudi industrijskih odkovkov in izdelkov iz pločevine.

SCHMIEDETRADITION SEIT 1573
HOCHWERTIGE MATERIALIEN IM EINSATZ
QUALITÄTSBEWUSSTEIN; DASS VERTRAUEN
SCHENKT

STRUC Kovačija

Unser Hauptsegment liegt in der Herstellung von landwirtschaftlichen Werkzeugen, Bau- und Gartengeräten sowie industriellen Schmiedeteilen und Blecherzeugnissen.

TRADITION SINCE 1573
MATERIALS OF HIGH QUALITY IN USE
A QUALITY CONSCIOUSNESS WHICH PROVIDES
CONFIDENCE

STRUC Kovačija

In Slovenia, we produce mainly agricultural-, contractors- and gardening tools as well as industrial forgings and sheet metals.



STRUC



- STRUC Kovačija Muta d.o.o.
- STRUC MUTA, kmetijska mehanizacija d.o.o.
- STRUC Ekoing d.o.o.
www.struc.info
- Adolf Struc nepremičnine d.o.o.
www.nepremicnine.struc.info



Mr. Adolf Struc, Owner of Struc Kovačija Muta

Mr. Alexander Struc, General Manager of Struc Kovačija Muta



Zagotavljamo Vam najboljšo kakovost in strokovno izdelavo naših izdelkov.

Wir garantieren Ihnen beste Qualität und saubere Verarbeitung unserer Produkte.

Best quality and accurate processing of our products are taken for granted.

STRUC KOVAČIJA MUTA

Tradicija, funkcionalnost in sodobnost.

Železarstvo na Muti je obstajalo že leta 1573. Osnovni pogoji za njegov razvoj so bili bogati pohorski gozdovi, vodna sila in nahajališča železove rude.

V svoji zgodovini je tovarna na Muti zamenjala več lastnikov, svoj največji razcvet pa je dosegla leta 1997, ko je novi lastnik postal g. Adolf Struc iz Nemčije. Na domačem in tujem tržišču se vedno bolj uveljavlja kot proizvajalka poljedelskega, vrtnega in cvetličnega orodja.

Izdelki, ki prihajajo iz tovarne Muta se ponašajo s skrbnostjo izdelave in kakovostjo, ki sta slavo tovarne vzdrževala skozi pretekla 4 stoletja, obenem pa so plod znanja in raziskovalnega dela strokovnjakov tovarne.

STRUC KOVAČIJA MUTA

Tradition und Gegenwart.

Alte Urkunden belegen, dass im bereits im Jahr 1573 Eisenhütten in Muta angesiedelt waren. Die Entstehung und die spätere Entwicklung der Eisenindustrie war möglich, weil die Gegend reich an Eisenerz, Holz und Wasser war.

In seiner langen Geschichte hat das Werk in Muta mehrmals den Eigentümer gewechselt, Höhen und Tiefen erlebt und erblühte im Jahre 1997, als Herr Adlof Struc der neue Eigentümer geworden ist. Heute ist STRUC Kovačija in Muta auf dem heimischen und dem internationalen Markt ein angesehener Gerätehersteller für Gartenbedarf und Landwirtschaft.

STRUC Kovačija Muta ist seit ehedem bekannt für die erstklassige Qualität und sorgfältige Ausarbeitung aller Erzeugnisse. Motivierte Fachleute sorgen für die Weiterentwicklung der bewährten Geräte und die Entwicklung neuer Modelle.

STRUC KOVAČIJA MUTA

Ironworking in the past and nowadays.

Muta has been holding tradition in ironworks since 1573. Its progress has been essentially based upon rich woods of Pohorje, abundant water power and iron deposits.

In the past the ironworks in Muta changed many owners. Since 1997 with the new owner, Mr. Adolf Struc from Germany, the factory is experiencing its golden age and establishing itself by launching its products - agricultural and garden tools - to home and foreign markets.

The products of Muta take pride upon their workmanship and prime quality that has maintained the good reputation of the factory for the last four centuries. At the same time they are the result of knowledge and research work of Muta specialist.

Znotraj podjetja STRUC Kovačija Muta d.o.o. deluje naše hčerinsko podjetje STRUC Ekoing d.o.o.. Poleg izdelave invalidskih stolov in vrtnih vozičkov je osnovna dejavnost podjetja izvajanje storitev kot so montaža, varjenje, nasajevanje, etiketiranje, pakiranje,... za STRUC Kovačijo Muta, kot tudi za druga podjetja. Cilj podjetja je ohraniti obstoječe delo, posodobiti tehnološke procese, ter iskanje in izvajanje novih programov in storitev.

Die STRUC Ekoing d.o.o. ist eine Tochtergesellschaft der STRUC Kovačija Muta d.o.o.. Neben der Herstellung von Schubkarren und Sitzhilfen für den Industriebedarf ist die Haupttätigkeit der STRUC Ekoing d.o.o. der Dienstleistungsbereich, wie z.B. Montagearbeiten, Schweißen, Etikettierung und Verpackung für die STRUC Kovačija als auch für externe Kunden.

Ziel ist die Bestandswahrung, die Optimierung der Prozesse sowie die Entwicklung neuer Programme und Dienstleistungen.

Inside of STRUC Kovačija Muta d.o.o. operate our on-site subsidiary company STRUC Ekoing d.o.o.. Company is occupied with production of invalid chairs and garden carts. Main activity of STRUC Ekoing are services like assembling, welding, handle assembling, labelling, packing,... for STRUC Kovačija Muta and other companies. Company purpose is to preserve existent work, to modernize technological processes, searching and performing new programmes and services.





PREVERILI SMO TRAJNOST IN
VZDRŽLJIVOST NAŠIH IZDELKOV

VON UNS AUF LANGLEBIGKEIT
UND ROBUSTHEIT GEPRÜFT

LONGEVITY AND
ROBUSTENESS ARE CERTIFIED



VILE, PIRUNI IN KOPAČI

vile za seno, gnoj, krompir, kamen,...
piruni, kopači za gnoj, kopači iz piruna,...

GABELN, SPATENGABELN UND HACKEN

Heugabeln, Dunggabeln,
Kartoffelgabeln, Steingabeln,...
Spatengabeln, Dunghacken,
Spatenhacken,...



FORKS, DIGGING FORKS AND CROCKS

hay forks, manure forks, potato forks, stone forks,...
digging forks, manure crocks, garden crocks,...

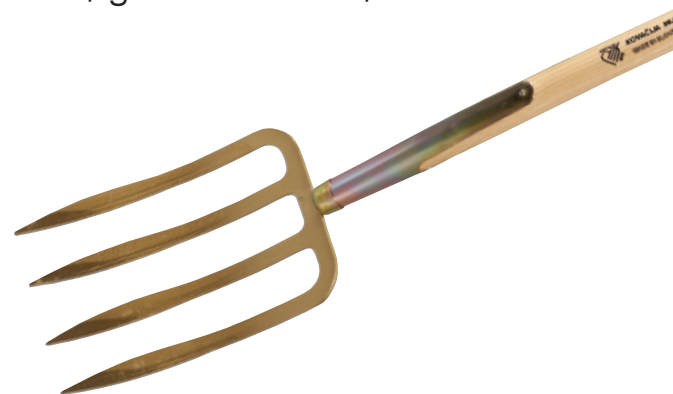



LOPATA STRUC KOVAČIJA MUTA
JE TRAJNA

SCHAUFELN VON KOVAČIJA MUTA
HÄLT DURCH

SHOVELS OF KOVAČIJA MUTA
STAYS THE COURSE



VALJANE IN PLOČEVINASTE LOPATE

lopate bavarske, lopate
hlevske, lopate za pesek,...



GEWALZTE SCHAUFELN UND SCHAUFELN AUS BLECH

Bayerische Schaufeln,
Randschaufeln, Hollsteiner
Schaufeln,...



ROLLED AND SHEET METAL SHOVELS

shovels bavaria, stable shovels,
sand shovels,...



ZAHTEVNO DELO POTREBUJE
KAKOVOSTNO ORODJE

GUTE ARBEIT
BRAUCHT GUTES WERKZEUG

GOOD TOOLS FOR GOOD WORK

ŠTEVILNI MODELI MOTIK

VERSCHIEDENE HACKENMODELLE

VARIOUS HOE TYPES





Z NAŠIM ORODJEM GRE LAŽJE

MIT UNSEREN WERKZEUG GEHT
ES LEICHTER

WITH OUR TOOLS IT'S EASIER
TO WORK

GRABLJE ZA RAZLIČNE NAMENE

vrtno, cestarske, grablje za asfalt,...



RECHEN FÜR VERSCHIEDENE ZWECKE

Gartenrechen, Straßenrechen,
Teerrechen,...



RAKES FOR DIFFERENT PURPOSES

garden rakes, road rakes,
asphalt rakes,...





NAKUP NAŠEGA ORODJA
JE DOBRA ODLOČITEV

DER KAUF UNSERER WERKZEUGE
IST EINE GUTE ENTSCHEIDUNG

BUYING OUR TOOLS IS A GOOD
DECISION



LOPATE ZA SNEG IN STRGALA

snežne lopate Alu-9, Alu-7,
Alu-400,...

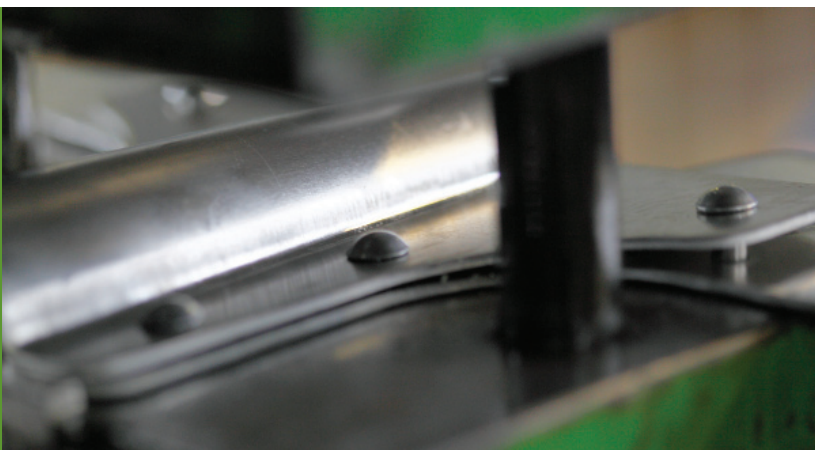

SCHNEESCHAUFELN UND STOßSCHARREN

Schneeschaufeln Alu-9, Alu-7,
Alu-400,...

SNOW SHOVELS AND ICE SCRAPERS

snow shovels Alu-9, Alu-7,
Alu-400,...



TRADICIJA STOLETIJ
JAHRHUNDERTLANGE TRADITION
CENTURIES OF TRADITION

STRUC KOVAČIJA MUTA d.o.o.



www.struc.info

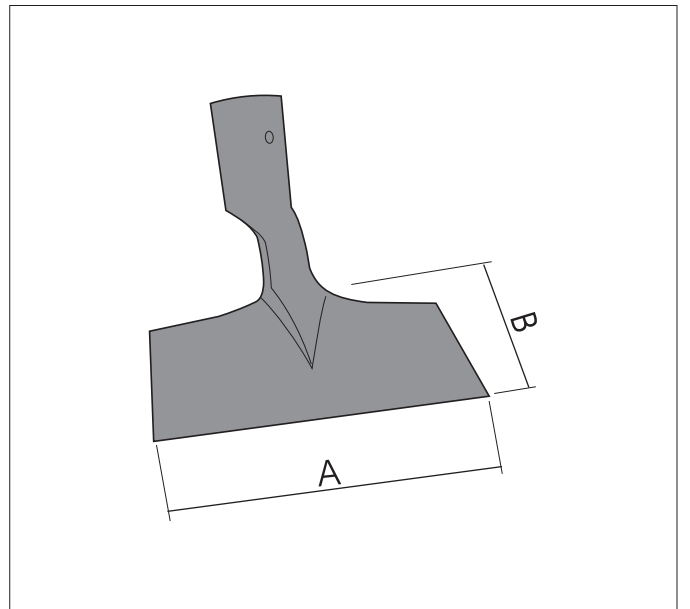
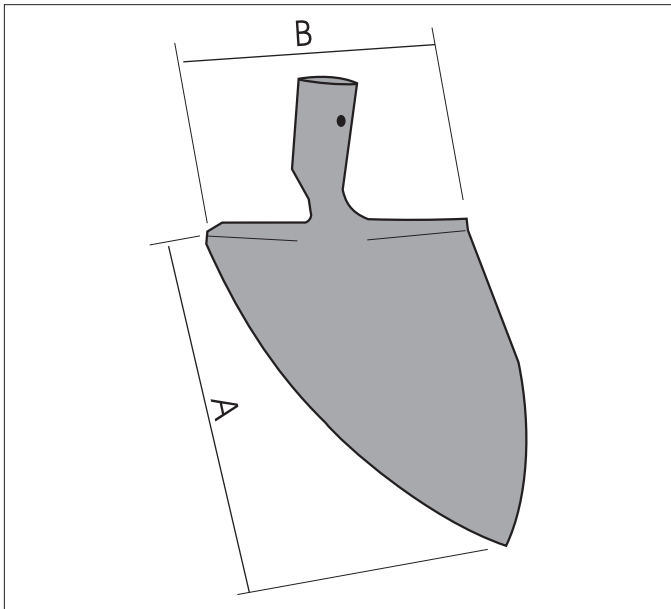
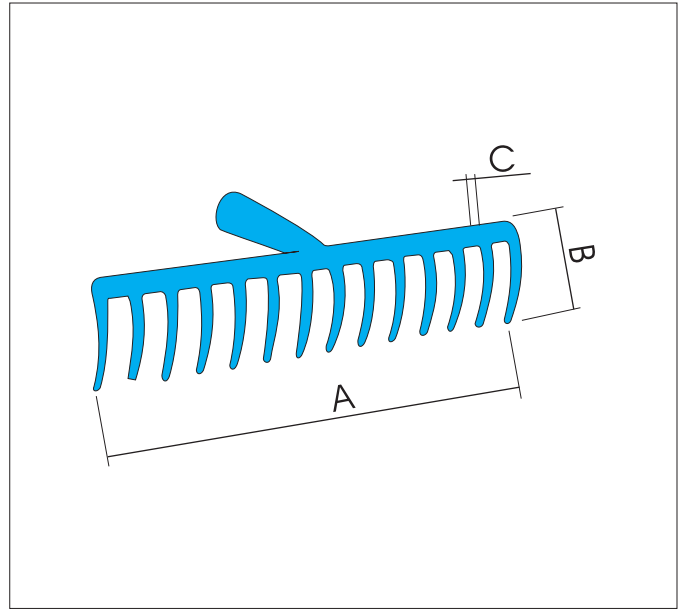
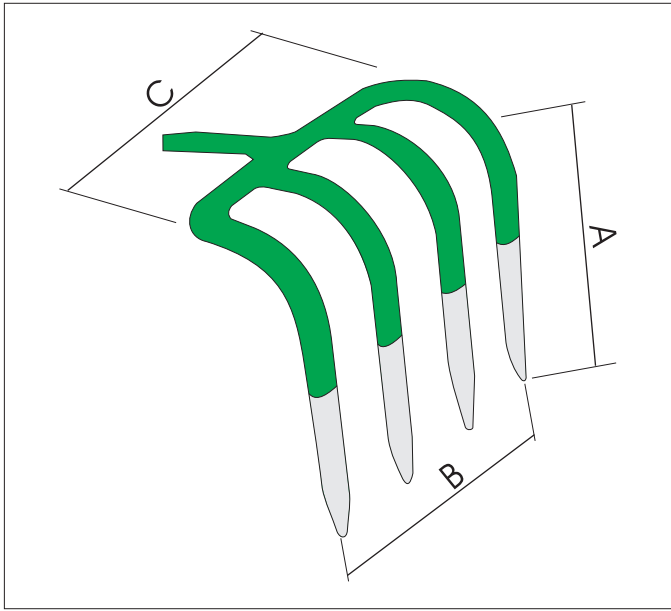
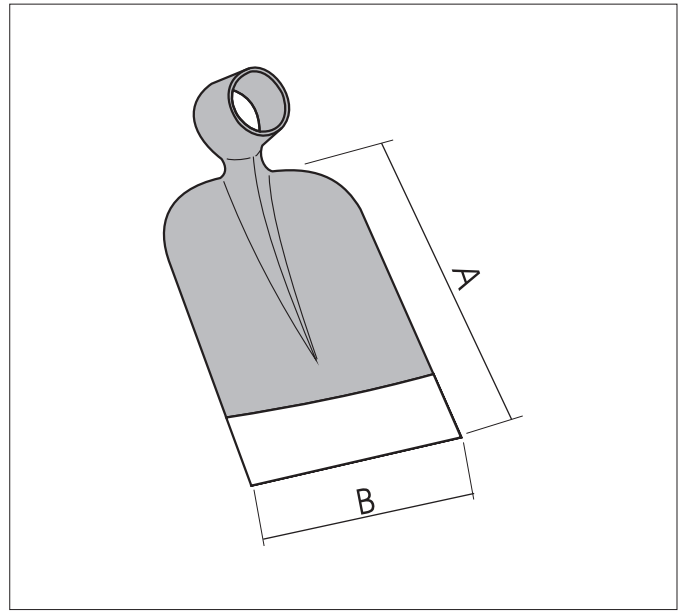
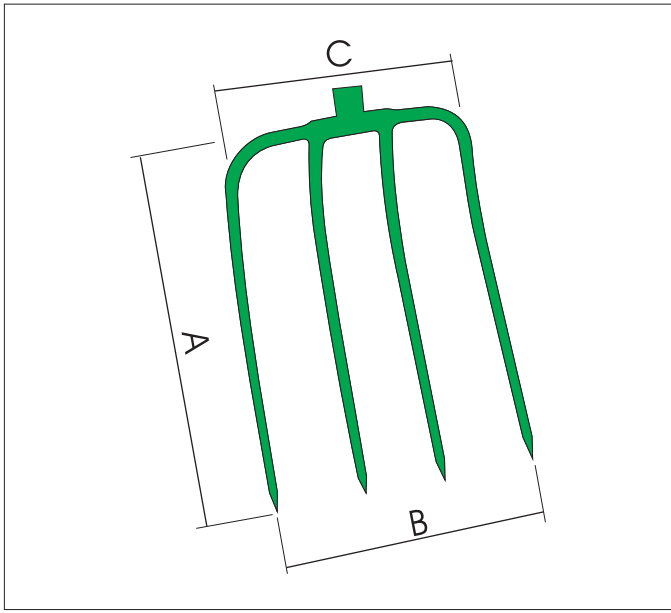



VILE, PIRUNI IN KOPAČI
GABELN, SPATENGABELN UND HACKEN
FORKS, DIGGING FORKS AND CROCKS

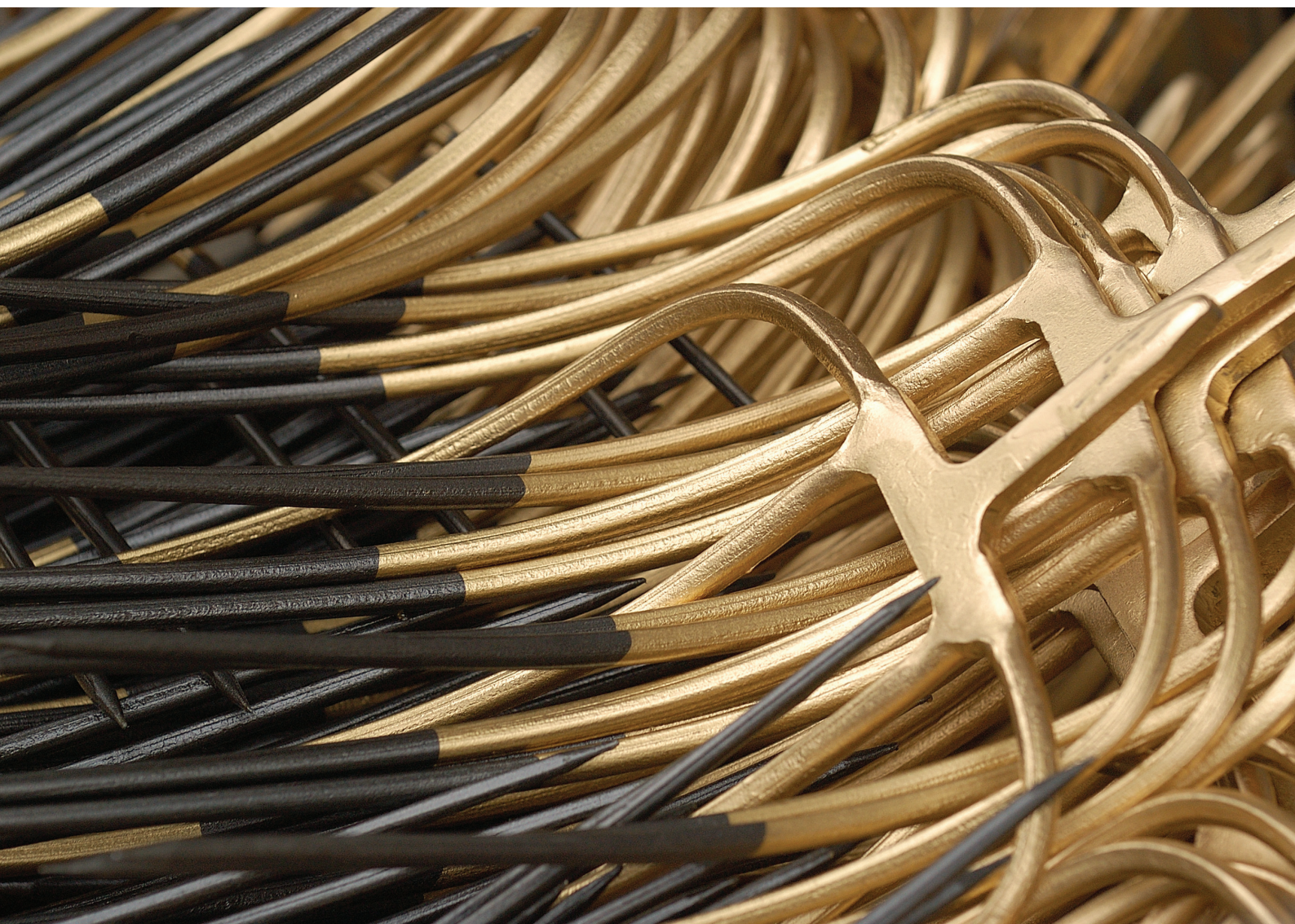

VILE ZA SNOPE 2R
BALLENGABEL 2 ZINKEN

BALE FORK 2 PRONGS
FOURCHE R BALLOT 2 DENTS

| | Art. No. | (AxBxC) | | | <i>i</i> |
|--|----------|-----------------|------|------|----------|
| | 776 471 | 250 x 150 x 130 | 0,40 | - | - |
| | 758 767 | 280 x 150 x 135 | 0,45 | - | - |
| | 716 117 | 310 x 160 x 130 | 0,45 | - | - |
| | 763 986 | 310 x 160 x 130 | 0,45 | - | - |
| | 752 833 | 250 x 150 x 130 | 1,30 | 1300 | - |
| | 752 832 | 310 x 160 x 130 | 1,45 | 1300 | - |
| | 758 674 | 240 x 160 x 145 | 0,30 | - | - |
| | 776 312 | 250 x 150 x 130 | 0,30 | - | - |
| | 758 752 | 258 x 150 x 130 | 0,30 | - | - |
| | 758 794 | 260 x 150 x 130 | 0,40 | - | - |
| | 758 675 | 280 x 150 x 125 | 0,35 | - | - |
| | 776 308 | 310 x 160 x 130 | 0,40 | - | - |
| | 776 315 | 250 x 150 x 130 | 1,25 | 1350 | - |
| | 776 313 | 250 x 150 x 130 | 1,00 | T850 | - |
| | 776 311 | 310 x 160 x 130 | 1,35 | 1350 | - |
| | 776 309 | 310 x 160 x 130 | 1,10 | T850 | - |
| | 762 341 | 240 x 160 x 145 | 1,25 | 1350 | - |

VILE ZA SENO S PROTIROGLOM
HEUGABEL MIT GEGENZINKEN

HAY FORK
FOURCHE À FOIN

| | Art. No. | (AxBxC) | | | <i>i</i> |
|--|----------|-----------------|------|------|----------|
| | 716 128 | 300 x 220 x 165 | 0,60 | - | - |
| | 752 837 | 300 x 220 x 165 | 1,50 | 1300 | - |
| | 776 328 | 300 x 220 x 165 | 0,50 | - | - |
| | 776 332 | 340 x 300 x 205 | 0,55 | - | - |
| | 776 331 | 300 x 220 x 165 | 1,45 | 1350 | - |
| | 776 329 | 300 x 220 x 165 | 1,20 | T850 | - |
| | 776 335 | 380 x 300 x 205 | 1,50 | 1350 | - |
| | 776 333 | 380 x 300 x 205 | 1,25 | T850 | - |
| | 716 129 | 380 x 300 x 205 | 0,65 | - | - |
| | 752 838 | 380 x 300 x 205 | 1,55 | 1300 | - |

VILE ZA GNOJ 3 R
DUNGGABEL 3 ZINKEN

MANURE FORK 3 PRONGS
FOURCHE À FUMIER 3 DENTS

| | Art. No. | (AxBxC) | | | <i>i</i> |
|--|----------|-----------------|------|------|----------|
| | 758 792 | 280 x 210 x 190 | 0,60 | - | - |
| | 716 121 | 300 x 230 x 190 | 0,55 | - | - |
| | 752 839 | 300 x 230 x 190 | 1,55 | 1300 | - |
| | 758 770 | 280 x 220 x 190 | 0,50 | - | - |
| | 776 303 | 300 x 230 x 190 | 0,50 | - | - |
| | 776307 | 300 x 230 x 190 | 1,45 | 1350 | - |
| | 755 663 | 300 x 230 x 190 | 0,65 | - | - |

VILE ZA SENO 3 R
HEUGABEL 3 ZINKEN

HAY FORK 3 PRONGS
FOURCHE À FOIN 3 DENTS

| | Art. No. | (AxBxC) | | | <i>i</i> |
|--|----------|-----------------|------|------|----------|
| | 776 472 | 260 x 200 x 165 | 0,50 | - | - |
| | 776 477 | 280 x 210 x 165 | 0,55 | - | - |
| | 716 124 | 300 x 220 x 165 | 0,60 | - | - |
| | 754 472 | 300 x 300 x 240 | 0,65 | - | - |
| | 752 835 | 260 x 200 x 165 | 1,40 | 1300 | - |
| | 752 834 | 280 x 210 x 165 | 1,45 | 1300 | - |
| | 779 773 | 300 x 220 x 165 | 1,50 | 1300 | - |
| | 776 473 | 260 x 200 x 165 | 0,45 | - | - |
| | 759 887 | 275 x 190 x 135 | 0,46 | - | - |
| | 776 478 | 280 x 210 x 165 | 0,50 | - | - |
| | 776 316 | 300 x 220 x 165 | 0,50 | - | - |
| | 776 320 | 300 x 180 x 165 | 0,50 | - | - |
| | 776 353 | 300 x 300 x 240 | 0,50 | - | - |
| | 763 028 | 340 x 310 x 270 | 0,60 | - | - |
| | 762 305 | 340 x 320 x 295 | 0,60 | - | - |
| | 776 385 | 300 x 300 x 240 | 1,45 | 1350 | - |
| | 776 383 | 300 x 300 x 240 | 1,20 | T850 | - |
| | 776 476 | 260 x 200 x 165 | 1,40 | 1350 | - |
| | 776 481 | 280 x 210 x 165 | 1,45 | 1350 | - |
| | 776 319 | 300 x 220 x 165 | 1,45 | 1350 | - |
| | 776 321 | 300 x 180 x 165 | 1,20 | T850 | - |
| | 762 225 | 300 x 300 x 240 | 1,60 | 1350 | - |
| | 762 306 | 340 x 320 x 295 | 1,55 | 1350 | - |
| | 776 327 | 370 x 280 x 205 | 1,50 | 1350 | - |
| | 776 325 | 370 x 280 x 205 | 1,25 | T850 | - |
| | 759 906 | 260 x 200 x 165 | 0,55 | - | - |
| | 776 482 | 300 x 300 x 240 | 0,65 | - | - |
| | 759 645 | 300 x 220 x 165 | 0,60 | - | - |
| | 763 029 | 340 x 310 x 270 | 0,65 | - | - |
| | 759 325 | 340 x 320 x 295 | 0,65 | - | - |
| | 716 127 | 340 x 280 x 205 | 0,65 | - | - |
| | 759 646 | 300 x 220 x 165 | 1,50 | 1300 | - |
| | 752 836 | 300 x 300 x 240 | 1,60 | 1300 | - |
| | 739 482 | 340 x 280 x 205 | 1,55 | 1300 | - |

VILE ZA KOMPOST 3 R
KLEIN KOMPOSTGABEL 3 ZINKEN

ROSE TREE FORK 3 PRONGS
FOURCHE À ROSIER 3 DENTS

| | Art. No. | (AxBxC) | | | <i>i</i> |
|--|----------|---------------|------|------|----------|
| | 758 986 | 170 x 85 x 75 | 0,30 | - | - |
| | 759 614 | 170 x 85 x 75 | 1,50 | 1350 | - |
| | 762 819 | 170 x 85 x 75 | 1,10 | 1200 | - |

VILE ZA KROMPIR 4 R
KARTOFFELGABEL 4 ZINKEN

POTATO FORK 4 PRONGS
FOURCHE À POMMES DE TERRE

| | Art. No. | (AxBxC) | | | <i>i</i> |
|--|----------|-----------------|------|---|----------|
| | 759 598 | 310 x 230 x 210 | 0,80 | - | - |

VILE ZA GNOJ 4 R
DUNGGABEL 4 ZINKEN

MANURE FORK 4 PRONGS
FOURCHE À FUMIER 4 DENTS

| | Art. No. | (AxBxC) | | | <i>i</i> |
|--|----------|-----------------|------|-------|----------|
| | 776 486 | 280 x 220 x 185 | 0,70 | - | - |
| | 716 120 | 310 x 230 x 210 | 0,75 | - | - |
| | 748 066 | 310 x 230 x 210 | 0,75 | - | - |
| | 759 886 | 310 x 220 x 180 | 0,80 | - | - |
| | 716 133 | 310 x 230 x 185 | 0,75 | - | - |
| | 776 487 | 280 x 220 x 185 | 1,60 | 1300 | - |
| | 776 086 | 310 x 230 x 185 | 1,65 | 1300 | - |
| | 776 336 | 310 x 230 x 210 | 1,65 | 1300 | - |
| | 773 457 | 280 x 220 x 185 | 0,60 | - | - |
| | 776 490 | 310 x 230 x 185 | 0,65 | - | - |
| | 758 670 | 310 x 230 x 210 | 0,70 | - | - |
| | 773 459 | 310 x 230 x 210 | 0,65 | - | - |
| | 776 088 | 280 x 220 x 185 | 1,35 | T850 | - |
| | 759 826 | 280 x 220 x 185 | 1,35 | Dm850 | - |
| | 776 091 | 310 x 230 x 210 | 1,70 | 1350 | - |
| | 776 092 | 310 x 230 x 210 | 1,45 | T850 | - |
| | 759 402 | 310 x 230 x 210 | 1,30 | Pd850 | - |
| | 757 416 | 310 x 230 x 210 | 1,70 | K1200 | - |
| | 757 414 | 310 x 230 x 210 | 1,35 | Kt800 | - |
| | 757 415 | 310 x 230 x 210 | 1,35 | Kd800 | - |
| | 776 492 | 310 x 230 x 185 | 1,60 | 1350 | - |
| | 776 491 | 310 x 230 x 185 | 1,40 | T850 | - |
| | 713 891 | 280 x 220 x 185 | 0,75 | - | - |
| | 758 672 | 310 x 230 x 185 | 0,85 | - | 10 mm |
| | 758 768 | 310 x 230 x 210 | 0,75 | - | - |
| | 776 627 | 310 x 230 x 210 | 0,80 | - | - |
| | 776 628 | 280 x 220 x 185 | 1,65 | 1300 | - |
| | 753 297 | 310 x 230 x 210 | 2,15 | 1300 | - |
| | 758 196 | 310 x 230 x 210 | 1,05 | - | - |
| | 758 260 | 310 x 230 x 210 | 1,60 | T850 | - |

VILE ZA KOMPOST 5 R
KOMPOSTGABEL 5 ZINKEN

COMPOST FORK 5 PRONGS
FOURCHE À COMPOST 5 DENTS

| | Art. No. | (AxBxC) | | | <i>i</i> |
|--|----------|-----------------|------|-------|----------|
| | 752 848 | 280 x 210 x 190 | 0,85 | - | - |
| | 752 849 | 280 x 210 x 190 | 1,75 | 1300 | - |
| | 763 046 | 270 x 210 x 190 | 0,75 | - | - |
| | 744 873 | 280 x 210 x 190 | 0,75 | - | - |
| | 739 973 | 280 x 210 x 190 | 1,70 | 1350 | - |
| | 759 656 | 280 x 210 x 190 | 1,45 | T850 | - |
| | 752 850 | 280 x 210 x 190 | 1,65 | T1100 | - |
| | 752 851 | 280 x 210 x 190 | 0,90 | - | - |
| | 752 852 | 280 x 210 x 190 | 1,80 | 1300 | - |

VILE ZA REPO 6R
RÜBENGABEL 6 ZINKEN

BEEF FORK 6 PRONGS
FOURCHE À BETTE RAVES 6 DENTS

| | Art. No. | (AxBxC) | | | <i>i</i> |
|--|----------|-----------------|------|------|----------|
| | 763 088 | 360 x 270 x 270 | 1,50 | - | - |
| | 763 089 | 360 x 270 x 270 | 1,45 | - | - |
| | 716 135 | 360 x 270 x 270 | 1,55 | - | - |
| | 752 853 | 360 x 270 x 270 | 2,45 | 1300 | - |

VILE ZA KORUZO 6 R
MAISGABEL 6 ZINKEN

MAIZE FORK 6 PRONGS
FOURCHE À MAIS 6 DENTS

| | Art. No. | (AxBxC) | | | <i>i</i> |
|--|----------|-----------------|------|------|----------|
| | 754 470 | 375 x 330 x 270 | 1,40 | - | - |
| | 754 471 | 375 x 330 x 270 | 1,30 | - | - |
| | 738 811 | 375 x 330 x 270 | 1,40 | - | - |
| | 752 854 | 375 x 330 x 270 | 2,30 | 1300 | - |

VILE ZA GNOJ 5 R
DUNGGABEL 5 ZINKEN

MANURE FORK 5 PRONGS
FOURCHE À FUMIER 5 DENTS

| | Art. No. | (AxBxC) | | | <i>i</i> |
|--|----------|-----------------|------|-------|----------|
| | 729 457 | 320 x 250 x 230 | 1,10 | - | - |
| | 716 151 | 320 x 250 x 230 | 1,10 | - | - |
| | 714 393 | 320 x 250 x 230 | 2,00 | 1300 | - |
| | 758 671 | 320 x 250 x 230 | 0,90 | - | - |
| | 776 134 | 320 x 250 x 230 | 0,95 | - | - |
| | 752 840 | 320 x 250 x 230 | 1,90 | 1350 | - |
| | 776 135 | 320 x 250 x 230 | 1,65 | T850 | - |
| | 757 419 | 320 x 250 x 230 | 1,95 | K1200 | - |
| | 757 417 | 320 x 250 x 230 | 1,60 | Kt800 | - |
| | 757 418 | 320 x 250 x 230 | 1,60 | Kd800 | - |
| | 752 846 | 320 x 250 x 230 | 1,15 | - | - |
| | 752 847 | 320 x 250 x 230 | 2,05 | 1300 | - |
| | 758 197 | 320 x 250 x 230 | 1,35 | - | - |
| | 758 261 | 320 x 250 x 230 | 2,05 | T850 | - |

VILE ZA SILOS 6R
SILOGABEL 6 ZINKEN

ENSILAGE FORK 6 PRONGS
FOURCHE À ENSILAGE 6 DENTS

| | Art. No. | (AxBxC) | | | <i>i</i> |
|--|----------|-----------------|------|------|----------|
| | 754 468 | 375 x 300 x 270 | 1,30 | - | - |
| | 754 469 | 375 x 300 x 270 | 1,20 | - | - |
| | 758 788 | 310 x 300 x 270 | 1,20 | - | - |
| | 739 324 | 375 x 300 x 270 | 1,35 | - | - |
| | 752 855 | 375 x 300 x 270 | 2,25 | 1300 | - |

VILE ZA KAMEN 8 R
STEINGABEL 8 ZINKEN

STONE FORK 8 PRONGS
FOURCHE À CAILLOUX 8 DENTS

| | Art. No. | (AxBxC) | | | <i>i</i> |
|--|----------|-----------------|------|------|----------|
| | 716 152 | 375 x 250 x 250 | 1,60 | - | - |
| | 752 856 | 375 x 250 x 250 | 2,50 | 1300 | - |

VILE ZA KROMPIR 8 R
KARTOFFELGABEL 8 ZINKEN

POTATO FORK 8 PRONGS
FOURCHE À POMMES DE TERRE 8 DENTS

| Art. No. | (A x B x C) | | | <i>i</i> |
|----------|-----------------|------|------|----------|
| 748 068 | 375 x 250 x 250 | 1,60 | - | - |
| 752 857 | 375 x 250 x 250 | 2,50 | 1300 | - |

VILE ZA KROMPIR
KARTOFFELGABEL

POTATO FORK
FOURCHE À POMMES DE TERRE

| Art. No. | (A x B x C) | | | <i>i</i> |
|----------|-----------------|------|------|----------|
| 757 912 | 400 x 320 x 300 | 1,70 | - | - |
| 758 041 | 400 x 320 x 300 | 2,60 | 1300 | - |

VILE ZA KROMPIR 9 R
KARTOFFELGABEL 9 ZINKEN

POTATO FORK 9 PRONGS
FOURCHE À POMMES DE TERRE 9 DENTS

| Art. No. | (A x B x C) | | | <i>i</i> |
|----------|-----------------|------|-------|----------|
| 759 674 | 365 x 280 x 260 | 1,90 | - | - |
| 759 664 | 365 x 280 x 260 | 2,70 | Md850 | - |
| 716 811 | 365 x 280 x 260 | 1,80 | - | - |
| 763 771 | 365 x 280 x 260 | 1,95 | - | - |
| 748 069 | 365 x 280 x 260 | 1,95 | - | - |
| 752 858 | 365 x 280 x 260 | 2,85 | 1300 | - |

VILE ZA ODPADKE 20 ZOB
PFERDEGABEL 20 ZINKEN

SHAVING FORK 20 PRONGS
FOURCHE À ORDURE 20 DENTS

| Art. No. | (A x B x C) | | | <i>i</i> |
|----------|-----------------|------|-------|----------|
| 757 487 | 290 x 340 x 380 | 1,25 | - | - |
| 756 280 | 290 x 340 x 380 | 2,00 | K1200 | - |
| 763 036 | 290 x 340 x 380 | 2,00 | 1500 | - |
| 763 751 | 290 x 340 x 380 | 2,00 | 1500 | - |

VILE ŽELEZNIČARSKÉ 9 R
STEINGABEL 9 ZINKEN

STONE FORK 9 PRONGS
FOURCHE À CHEMIN DE FER 9 DENTS

| Art. No. | (A x B x C) | | | <i>i</i> |
|----------|-----------------|------|------|----------|
| 739 866 | 365 x 280 x 260 | 1,75 | - | - |
| 752 860 | 365 x 280 x 260 | 2,65 | 1300 | - |
| 757 001 | 365 x 280 x 260 | 2,55 | D770 | - |
| 716 803 | 365 x 280 x 260 | 1,65 | - | - |
| 716 153 | 365 x 280 x 260 | 1,90 | - | - |

PIRUN
SPATENGABEL

DIGGING FORK
FOURCHE À BÉCHER

| Art. No. | (A x B x C) | | | <i>i</i> |
|----------|-----------------|------|------|----------|
| 766 607 | 170 x 110 x 110 | 0,45 | - | - |
| 766 610 | 170 x 110 x 110 | 0,70 | T400 | - |

VILE ZA GRAMOZ 9 R
STEINGABEL 9 ZINKEN

STONE FORK 9 PRONGS
FOURCHE À CALLIOUX 9 DENTS

| Art. No. | (A x B x C) | | | <i>i</i> |
|----------|-----------------|------|-------|----------|
| 738 299 | 350 x 240 x 240 | 1,90 | - | - |
| 752 859 | 350 x 240 x 240 | 2,80 | 1300 | - |
| 762 138 | 350 x 240 x 240 | 2,70 | Md850 | - |
| 729 454 | 350 x 240 x 240 | 1,90 | - | - |
| 776 093 | 350 x 240 x 240 | 2,80 | 1300 | - |
| 759 873 | 350 x 240 x 240 | 2,60 | T850 | - |

VILE ZA KOKS 12 R
KOKSGABEL 12 ZINKEN

COKE FORK 12 PRONGS
FOURCHE À CARBON 12 DENTS

| Art. No. | (A x B x C) | | | <i>i</i> |
|----------|-----------------|------|------|----------|
| 729 161 | 470 x 400 x 400 | 3,30 | - | - |
| 752 863 | 470 x 400 x 400 | 4,20 | 1300 | - |

PIRUN CVETLIČNI
ROSENGABE

DIGGING FORK
FOURCHE À BÉCHER

| Art. No. | (A x B) | | | <i>i</i> |
|----------|-----------|------|---|----------|
| 758 793 | 300 x 140 | 0,80 | - | - |
| 763 017 | 270 x 120 | 0,65 | - | - |

PIRUN KARO
SPATENGABEL

GARDEN FORK
FOURCHE À BÉCHER

| Art. No. | (A x B x C) | | | <i>i</i> |
|----------|-----------------|------|------|----------|
| 716 122 | 280 x 195 x 180 | 1,40 | - | - |
| 759 180 | 300 x 200 x 190 | 1,70 | - | - |
| 738 010 | 280 x 195 x 180 | 2,00 | 1000 | - |
| 762 353 | 300 x 200 x 190 | 2,35 | 1300 | - |

PIRUN
SPATENGABEL

DIGGING FORK
FOURCHE À BÉCHER

| Art. No. | (A x B) | | | <i>i</i> |
|----------|-----------|------|------|----------|
| 766516 | 250 x 170 | 0,95 | - | - |
| 766658 | 250 x 170 | 1,55 | T850 | - |
| 739 366 | 270 x 180 | 1,10 | - | - |
| 776 083 | 270 x 180 | 1,75 | 1000 | - |
| 762 354 | 270 x 180 | 2,00 | 1300 | - |
| 757 725 | 270 x 180 | 1,70 | T850 | - |
| 777 084 | 270 x 180 | 1,70 | D850 | - |
| 716 277 | 270 x 180 | 1,65 | G850 | - |
| 754 544 | 300 x 190 | 1,50 | - | ø38 |
| 762 156 | 300 x 190 | 1,50 | - | ø36 |
| 758 021 | 310 x 185 | 1,70 | - | ø40 |
| 759 017 | 300 x 190 | 2,30 | 1000 | ø38 |
| 759 018 | 300 x 190 | 2,15 | T850 | ø38 |
| 762 327 | 310 x 185 | 2,50 | 1100 | ø40 |
| 766 517 | 250 x 170 | 0,80 | - | - |
| 766659 | 250 x 170 | 1,65 | T850 | - |
| 729 642 | 270 x 180 | 0,95 | - | - |
| 776 085 | 270 x 180 | 1,65 | 1000 | - |
| 757 726 | 270 x 180 | 1,65 | T850 | - |
| 754 523 | 300 x 190 | 1,45 | - | - |
| 759 047 | 300 x 190 | 2,15 | 1000 | - |
| 758 166 | 300 x 190 | 2,05 | T850 | - |
| 764 032 | 270 x 180 | 1,15 | - | - |
| 755 848 | 300 x 190 | 1,50 | - | ø38 |
| 759 998 | 300 x 190 | 1,50 | - | ø40 |
| 755 951 | 300 x 190 | 2,00 | 1000 | ø38 |
| 758 167 | 300 x 190 | 2,05 | T850 | ø38 |

PIRUN Z DOLGO TULJAVO
SPATENGABEL MIT DOPPELFEDERDÜLLE

DIGGING FORK
FOURCHE À BÉCHER

| Art. No. | (A x B x C) | | | <i>i</i> |
|----------|-----------------|------|--------|----------|
| 758 472 | 270 x 180 x 180 | 1,25 | - | - |
| 758 470 | 300 x 190 x 190 | 1,75 | - | - |
| 758 475 | 270 x 180 x 180 | 1,80 | T850 | - |
| 758 473 | 300 x 190 x 190 | 2,20 | T850 | - |
| 759 600 | 300 x 190 x 190 | 2,50 | LYD780 | - |

PIRUN Z DOLGO TULJAVO - RAZŠIRJEN
SPATENGABEL MIT DOPPELFEDERDÜLLE - LANZENZINKEN

DIGGING FORK
FOURCHE À BÉCHER

| Art. No. | (A x B) | | | <i>i</i> |
|----------|-----------------|------|---|----------|
| 759 093 | 270 x 180 x 180 | 1,30 | - | - |
| 759 091 | 300 x 190 x 190 | 1,80 | - | - |

PIRUN VRTNI - RAZŠIRJEN
SPATENGABEL - LANZENZINKEN

DIGGING FORK WELDED
FOURCHE À BÉCHER

| Art. No. | (A x B) | | | <i>i</i> |
|----------|-----------|------|------|----------|
| 752 874 | 270 x 180 | 1,10 | - | ø36 |
| 754 520 | 300 x 190 | 1,50 | - | - |
| 758 022 | 310 x 185 | 1,80 | - | - |
| 752 876 | 270 x 180 | 1,70 | 1000 | ø36 |
| 757 727 | 270 x 180 | 1,65 | T850 | ø36 |
| 752 877 | 270 x 180 | 1,60 | D850 | ø36 |
| 762 582 | 310 x 185 | 2,60 | 1100 | - |
| 762 965 | 310 x 185 | 2,60 | T915 | - |
| 744 418 | 270 x 180 | 0,95 | - | - |
| 754 514 | 300 x 190 | 1,50 | - | - |
| 752 886 | 270 x 180 | 1,70 | 1000 | - |
| 757 728 | 270 x 180 | 1,65 | T850 | - |
| 752 887 | 270 x 180 | 1,65 | D850 | - |
| 762 538 | 300 x 190 | 2,10 | T850 | - |
| 759 136 | 270 x 180 | 1,10 | - | ø38 |
| 759 161 | 300 x 190 | 1,55 | - | - |

KOPAČ MALI 3 R
GARTENHACKE 3 ZINKEN

GARDEN CROCK 3 PRONGS
CROC 3 DENTS



| Art. No. | (A x B x C) | | | <i>i</i> |
|----------|----------------|------|------|----------|
| 739 836 | 140 x 100 x 90 | 0,25 | - | - |
| 739 956 | 140 x 100 x 90 | 1,00 | 1350 | - |

KOPAČ ZA GNOJ 3 R
DUNGHACKE 3 ZINKEN



MANURE CROCK 3 PRONGS
CROC À FUMIER 3 DENTS

| Art. No. | (A x B x C) | | | <i>i</i> |
|----------|-----------------|------|------|----------|
| 716 130 | 215 x 220 x 190 | 0,55 | - | - |
| 752 864 | 215 x 220 x 190 | 1,30 | 1300 | - |
| 763 047 | 270 x 210 x 190 | 0,50 | - | - |



KOPAČ ZA KROMPIR 4 R **POTATOES CROCK 4 PRONGS**
KARTOFFELHACKE 4 ZINKEN **CROC À POMMES DE TERRE 4 DENTS**

|  | Art. No. | (AxBxC) |  |  | <i>i</i> |
|--|----------|-----------------|---|---|----------|
| | | | | | |
| | 711 705 | 120 x 135 x 100 | 0,25 | - | - |
| | 739 862 | 120 x 135 x 100 | 1,20 | 1350 | - |



KOPAČ ZA GNOJ 4 R **MANURE CROCK 4 PRONGS**
DUNGHACKE 4 ZINKEN **CROC À FUMIER 4 DENTS**

|  | Art. No. | (AxBxC) |  |  | <i>i</i> |
|--|----------|-----------------|---|---|----------|
| | | | | | |
| | 752 483 | 210 x 220 x 210 | 0,80 | - | - |
| | 752 866 | 210 x 220 x 210 | 1,50 | 1300 | - |
| | 757 255 | 220 x 210 x 210 | 0,65 | - | - |
| | 762 343 | 220 x 210 x 210 | 1,50 | 1350 | - |
| | 757 676 | 210 x 220 x 210 | 0,85 | - | - |



KOPAČ ZA GNOJ 4 R **MANURE CROCK 4 PRONGS**
DUNGHACKE 4 ZINKEN **CROC À FUMIER 4 DENTS**

|  | Art. No. | (AxBxC) |  |  | <i>i</i> |
|--|----------|-----------------|---|---|----------|
| | | | | | |
| | 716 131 | 200 x 210 x 185 | 0,70 | - | - |
| | 776 079 | 200 x 210 x 185 | 1,50 | 1300 | - |
| | 758 589 | 200 x 210 x 185 | 0,70 | - | - |
| | 757 144 | 200 x 210 x 185 | 0,65 | - | - |
| | 759 750 | 200 x 210 x 185 | 1,50 | 1350 | - |
| | 757 675 | 200 x 210 x 185 | 0,75 | - | - |



KOPAČ ZA GNOJ 5 R **MANURE CROCK 5 PRONGS**
DUNGHACKE 5 ZINKEN **CROC À FUMIER 5 DENTS**

|  | Art. No. | (AxBxC) |  |  | <i>i</i> |
|--|----------|-----------------|---|---|----------|
| | | | | | |
| | 752 484 | 200 x 240 x 230 | 1,05 | - | - |
| | 752 867 | 200 x 240 x 230 | 1,95 | 1300 | - |
| | 757 256 | 200 x 240 x 230 | 1,00 | - | - |
| | 757 946 | 200 x 240 x 230 | 1,25 | - | - |





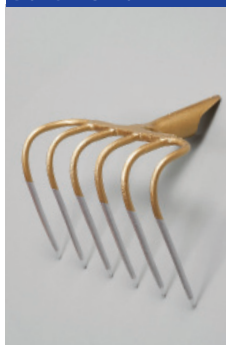

KOPAČ ZA GNOJ Z BUNKICAMI 4 R **MANURE CROCK 4 PRONGS**
DUNGHACKE 4 ZINKEN **CROC À FUMIER 4 DENTS**

|  | Art. No. | (AxBxC) |  |  | <i>i</i> |
|---|----------|-----------------|--|--|----------|
| | | | | | |
| | 759 644 | 200 x 210 x 185 | 0,75 | - | - |



KOPAČ ZA GNOJ 6 R **MANURE CROCK 6 PRONGS**
DUNGHACKE 6 ZINKEN **CROC À FUMIER 6 DENTS**

|  | Art. No. | (AxBxC) |  |  | <i>i</i> |
|---|----------|-----------------|--|--|----------|
| | | | | | |
| | 756 629 | 220 x 290 x 280 | 1,50 | - | - |



KOPAČ IZ PIRUNA 4 R **GARDEN CROCK 4 PRONGS**
SPATENHACKE 4 ZINKEN **CROC DE FORCHE À BÉCHER 4 DENTS**

|  | Art. No. | (AxBxC) |  |  | <i>i</i> |
|--|----------|---|---|---|----------|
| | | | | | |
| | 716 132 | 170 x 165 x 180 | 0,95 | - | - |
| | 752 868 | 200 x 165 x 180 | 0,95 | - | - |
| | 776 065 | 170 x 165 x 180 | 1,70 | 1100 | - |
| | 752 869 | 200 x 165 x 180 | 1,70 | 1100 | - |
| | 752 870 | 170 x 165 x 180 | 0,90 | - | - |
| | 752 872 | 200 x 165 x 180 | 0,90 | - | - |
| | 752 873 | 200 x 165 x 180 | 1,80 | 1200 | - |
| | 716 132 |  | | | |
| | 752 870 |  | | | |
| | 752 868 |  | | | |
| | 752 872 |  | | | |

VILE ZA PREZRAČEVANJE **BROADFORK**
TERRATOR **EXTRAIT**

|  | Art. No. | (AxBxC) |  |  | <i>i</i> |
|--|----------|-----------------|---|---|----------|
| | | | | | |
| | 765 725 | 320 x 385 x 530 | 3,75 | - | - |
| | 765 726 | 320 x 385 x 530 | 4,95 | 1100 | - |

KOPAČ IZ PIRUNA 4 R **GARDEN CROCK 4 PRONGS**
SPATENHACKE 4 ZINKEN **CROC DE FORCHE À BÉCHER 4 DENTS**

|  | Art. No. | (AxBxC) |  |  | <i>i</i> |
|--|----------|-----------------|---|---|----------|
| | | | | | |
| | 758 868 | 240 x 175 x 190 | 1,30 | - | - |

VILE ZA PREZRAČEVANJE Z OJAČITVIJO **BROADFORK**
TERRATOR **EXTRAIT**

|  | Art. No. | (AxBxC) |  |  | <i>i</i> |
|--|----------|-----------------|---|---|----------|
| | | | | | |
| | 766 454 | 320 x 385 x 530 | 4,60 | - | - |
| | 766 455 | 320 x 385 x 530 | 5,80 | 1100 | - |



LOPATE
SCHAUFELN UND SPATEN
SHOVELS AND SPADES



LOPATA BAVARSKA
BAYERISCHE SANDSCHAUFEL

SAND SHOVEL "BAVARIA"
PELLE



| Art. No. | (A x B) | | | <i>i</i> |
|----------|-----------|------|------|----------|
| 713 783 | 280 x 280 | 1,10 | - | - |
| 713 784 | 300 x 300 | 1,30 | - | - |
| 757 042 | 280 x 280 | 1,10 | - | - |
| 757 043 | 300 x 300 | 1,30 | - | - |
| 714 303 | 280 x 280 | 2,10 | 1250 | - |
| 714 302 | 300 x 300 | 2,30 | 1250 | - |
| 757 044 | 280 x 280 | 2,30 | 1250 | - |
| 757 045 | 300 x 300 | 2,30 | 1250 | - |

LOPATA PREMOGOVNA
BLECHKOHELSCHAUFEL

COAL SHOVEL
PELLE



| Art. No. | (A x B) | | | <i>i</i> |
|----------|-----------|------|------|----------|
| 729 452 | 350 x 290 | 1,80 | - | - |
| 777 491 | 350 x 290 | 2,80 | 1300 | - |
| 716 154 | 350 x 290 | 2,80 | D800 | - |

LOPATA KONIČASTA
SPITZSCHAUFEL

SHOVEL POINTED
PELLE



| Art. No. | (A x B) | | | <i>i</i> |
|----------|-----------|------|------|----------|
| 748 076 | 270 x 275 | 1,30 | - | - |
| 776 063 | 270 x 275 | 2,30 | 1250 | - |

LOPATA PONVASTA
PFANNENSCHAUFEL

COAL SHOVEL
PELLE



| Art. No. | (A x B) | | | <i>i</i> |
|----------|-----------|------|------|----------|
| 716 077 | 365 x 365 | 2,20 | - | 10° |
| 773 495 | 365 x 365 | 2,20 | - | 30° |
| 754 345 | 400 x 400 | 3,20 | 1300 | 30° |
| 755 061 | 365 x 365 | 3,00 | T540 | 30° |
| 755 062 | 365 x 365 | 3,20 | T740 | 30° |

LOPATA OKROGLA
RUNDSCHAUFEL

SHOVEL ROUND
PELLE



| Art. No. | (A x B) | | | <i>i</i> |
|----------|-----------|------|------|----------|
| 748 077 | 230 x 245 | 1,30 | - | - |
| 776 064 | 230 x 245 | 2,30 | 1250 | - |

LOPATA PREMOGOVNA
RANDSCHAUFEL

COAL SHOVEL
PELLE



| Art. No. | (A x B) | | | <i>i</i> |
|----------|-----------|------|------|----------|
| 716 105 | 295 x 285 | 1,30 | - | - |
| 754 344 | 295 x 285 | 2,30 | 1300 | - |

LOPATA RUDARSKA ŠIROKA
ENGLISCHESCHAUFEL-BREIT

SOLID SOCKET SQUARE
PELLE



| Art. No. | (A x B) | | | <i>i</i> |
|----------|-----------|------|--------|----------|
| 757 827 | 320 x 250 | 1,95 | - | ø34 |
| 757 828 | 320 x 250 | 1,95 | - | ø32 |
| 757 840 | 320 x 250 | 2,50 | T700 | ø34 |
| 757 841 | 320 x 250 | 2,80 | Md700 | ø34 |
| 757 842 | 320 x 250 | 2,75 | MYD700 | ø32 |

LOPATA HLEVSKA
RANDSCHAUFEL

STABLE SHOVEL
PELLE



| Art. No. | (A x B) | | | <i>i</i> |
|----------|-----------|------|------|----------|
| 716 106 | 270 x 220 | 0,90 | - | A |
| 716 107 | 285 x 235 | 1,00 | - | B |
| 754 342 | 270 x 220 | 1,90 | 1300 | A |
| 755 893 | 285 x 235 | 2,00 | 1300 | B |

LOPATA RUDARSKA OZKA
ENGLISCHE SCHAUFEL-SCHMAL

SOLID SOCKET TAPER
PELLE



| Art. No. | (A x B) | | | <i>i</i> |
|----------|-----------|------|--------|----------|
| 757 829 | 320 x 240 | 1,90 | - | ø34 |
| 757 830 | 320 x 240 | 1,90 | - | ø32 |
| 757 844 | 320 x 240 | 2,45 | T700 | ø34 |
| 757 845 | 320 x 240 | 2,75 | Md700 | ø34 |
| 757 846 | 320 x 240 | 2,75 | MYD700 | ø32 |

LOPATA UNIVERZALNA
RANDSCHAUFEL

SHOVEL UNIVERSAL
PELLE



| Art. No. | (A x B) | | | <i>i</i> |
|----------|-----------|------|------|----------|
| 716 108 | 275 x 235 | 0,95 | - | A |
| 716 109 | 285 x 260 | 1,05 | - | B |
| 738 690 | 275 x 235 | 1,90 | 1300 | A |
| 758 175 | 285 x 260 | 2,00 | 1300 | B |

LOPATA ZA ZEMLJO
SCHAUFEL FÜR ERDE

SHOVEL FOR SOIL
PELLE



| Art. No. | (AxB) | | | <i>i</i> |
|----------|-----------|------|------|----------|
| 716 110 | 250 x 250 | 1,05 | - | A |
| 716 111 | 270 x 275 | 1,15 | - | B |
| 757 939 | 250 x 250 | 2,05 | 1300 | A |
| 754 343 | 270 x 275 | 2,15 | 1300 | B |

LOPATA PONVASTA 6 RAVNA
BLECHSCHAUFEL NR. 6

OPEN SOCKET SHOVEL NO. 6
PELLE



| Art. No. | (AxB) | | | <i>i</i> |
|----------|-----------|------|-------|----------|
| 757 792 | 360 x 305 | 1,90 | - | - |
| 757 806 | 360 x 305 | 2,40 | T680 | - |
| 757 807 | 360 x 305 | 2,35 | Pd680 | - |

LOPATA METAČA "0", "00" & "000"
SCHAUFEL "0", "00" & "000"

SHOVEL "0", "00" & "000"
PELLE HOLLANDER "0", "00", "000"



| Art. No. | (AxB) | | | <i>i</i> |
|----------|-----------|------|---|----------|
| 756 507 | 270 x 220 | 0,88 | - | 0 |
| 756 505 | 260 x 215 | 0,85 | - | 00 |
| 756 504 | 260 x 215 | 0,80 | - | 000 |
| 759 159 | 260 x 215 | 0,80 | - | 000 1/4 |
| 757 535 | 205 x 168 | 0,42 | - | - |

LOPATA IRSKA
IRISCHE SCHAUFEL

IRISH ROUND MOUNTH SHOVEL
PELLE



| Art. No. | (AxB) | | | <i>i</i> |
|----------|-----------|------|------|----------|
| 757 963 | 360 x 260 | 1,50 | - | - |
| 757 962 | 360 x 260 | 2,65 | 1370 | - |

LOPATA ZA CENTRALNO KURJAVO
ZENTRALHEIZUNGSCHAUFEL

SHOVEL FOR CENTRAL HEATING
PELLE



| Art. No. | (AxB) | | | <i>i</i> |
|----------|-----------|------|-------|----------|
| 716 161 | 380 x 200 | 1,05 | - | - |
| 777 155 | 380 x 200 | 1,80 | Pd660 | - |

LOPATA METAČA 25
SCHAUFEL 25

SHOVEL 25
PELLE 25



| Art. No. | (AxB) | | | <i>i</i> |
|----------|-----------|------|---|----------|
| 759 333 | 290 x 260 | 1,30 | - | - |

LOPATA PONVASTA 2 RAVNA
BLECHSCHAUFEL NR. 2

OPEN SOCKET SHOVEL NO. 2
PELLE



| Art. No. | (AxB) | | | <i>i</i> |
|----------|-----------|------|-------|----------|
| 757 790 | 325 x 250 | 1,45 | - | - |
| 757 800 | 325 x 250 | 1,90 | T680 | - |
| 757 801 | 325 x 250 | 2,40 | 1200 | - |
| 757 802 | 325 x 250 | 1,90 | Pd680 | - |

LOPATA METAČA 27
SCHAUFEL 27

SHOVEL 27
PELLE 27



| Art. No. | (AxB) | | | <i>i</i> |
|----------|-----------|------|---|----------|
| 759 334 | 275 x 275 | 1,15 | - | - |

LOPATA PONVASTA 4 RAVNA
BLECHSCHAUFEL NR. 4

OPEN SOCKET SHOVEL NO. 4
PELLE



| Art. No. | (AxB) | | | <i>i</i> |
|----------|-----------|------|-------|----------|
| 757 791 | 335 x 275 | 1,60 | - | - |
| 757 803 | 335 x 275 | 2,10 | T680 | - |
| 757 804 | 335 x 275 | 2,50 | 1200 | - |
| 757 805 | 335 x 275 | 2,05 | Pd680 | - |

SMETIŠNICA
KEHRRICHTSCHAUFEL

HOUSEHOLD SHOVEL
PELLE



| Art. No. | (AxB) | | | <i>i</i> |
|----------|-----------|------|-----|----------|
| 757 337 | 260 x 235 | 0,65 | - | - |
| 757 335 | 260 x 235 | 0,75 | 250 | - |
| 757 336 | 260 x 235 | 0,75 | 250 | - |

LOPATICA ZA PREMOG
KOHLEKELLE

COAL SHOVEL
PELLE



| Art. No. | (A x B) | | | <i>i</i> |
|----------|-----------|------|-----|----------|
| 716 116 | 200 x 115 | 0,40 | - | - |
| 731 381 | 200 x 115 | 0,50 | 250 | - |

LOPATA PREKOPNA "BASALT"
SPATEN "BASALT"

SPADE "BASALT"
BÈCHE "BASALT"



| Art. No. | (A x B) | | | <i>i</i> |
|----------|-----------|------|------|----------|
| 737 843 | 285 x 185 | 1,30 | - | - |
| 739 504 | 285 x 185 | 2,00 | T850 | - |
| 739 503 | 285 x 185 | 2,00 | 1000 | - |

LOPATA PREKOPNA KONIČASTA
SPATEN SPITZ

SPADE
BÈCHE



| Art. No. | (A x B) | | | <i>i</i> |
|----------|-----------|------|------|----------|
| 716 098 | 280 x 230 | 1,20 | - | - |
| 754 340 | 280 x 230 | 2,20 | 1000 | - |

LOPATA RAVNA
SPATEN

SPADE
BÈCHE



| Art. No. | (A x B) | | | <i>i</i> |
|----------|-----------|------|------|----------|
| 777 597 | 270 x 180 | 1,25 | - | - |
| 777 083 | 270 x 180 | 1,70 | D850 | - |
| 777 598 | 270 x 180 | 1,65 | T850 | - |
| 777 600 | 270 x 180 | 1,75 | 1000 | - |

LOPATA PREKOPNA HERKULES
SPATEN "HERKULES"

SPADE "HERKULES"
BÈCHE



| Art. No. | (A x B) | | | <i>i</i> |
|----------|-----------|------|------|----------|
| 716 095 | 290 x 200 | 1,30 | - | - |
| 754 341 | 290 x 200 | 2,30 | 1000 | - |

LOPATA SULIČASTA
SPATEN

TABULAR FENCING SPADE
BÈCHE



| Art. No. | (A x B) | | | <i>i</i> |
|----------|-----------|------|-------|----------|
| 758 305 | 275 x 135 | 1,50 | - | - |
| 758 306 | 275 x 135 | 4,65 | K1370 | - |

LOPATA PREKOPNA
SPATEN

SPADE
BÈCHE



| Art. No. | (A x B) | | | <i>i</i> |
|----------|-----------|------|------|----------|
| 729 448 | 300 x 230 | 0,90 | - | - |
| 716 157 | 300 x 230 | 1,50 | 1000 | - |
| 759 763 | 300 x 230 | 1,50 | T850 | - |
| 729 447 | 300 x 230 | 1,50 | D850 | - |

LOPATA PREKOPNA HIT
SPATEN HIT

SPADE "HIT"
BÈCHE "HIT"



| Art. No. | (A x B) | | | <i>i</i> |
|----------|-----------|------|------|----------|
| 755 495 | 245 x 175 | 1,04 | - | 0 |
| 739 580 | 270 x 195 | 1,20 | - | 1 |
| 752 844 | 270 x 195 | 1,70 | T850 | - |
| 753 168 | 270 x 195 | 1,90 | 1000 | - |
| 755 497 | 245 x 175 | 1,85 | T850 | - |

LOPATA VRTNA VALJANA ECCO - HOLLAND
ECCO-SPATEN - HOLLAND MODEL

GARDEN SPADE ECCO ROLLING - HOLLAND
PELLE



| Art. No. | (A x B) | | | <i>i</i> |
|----------|-----------|------|------|-------------|
| 759 118 | 280 x 165 | 1,20 | - | LAK |
| 759 119 | 280 x 165 | 1,20 | - | BRUS/POLIRT |
| 759 060 | 280 x 165 | 2,00 | T780 | - |
| 759 061 | 280 x 165 | 2,00 | T780 | - |

LOPATA PREKOPNA SPATEN SPADE BËCHE



| Art. No. | (AxB) | | | <i>i</i> |
|----------|-----------|------|---|----------|
| 758 088 | 240 x 138 | 1,45 | - | - |

LOPATA ZA PESEK - OKROGLA HOLLÄNDER SCHAUFEL SHOVEL "HOLLÄND" PELLE "HOLLÄND"



| Art. No. | (AxBxC) | | | <i>i</i> |
|----------|-----------------|------|------|----------|
| 755 873 | 300 x 250 x 35° | 1,30 | - | 2 1/2 |
| 739 526 | 300 x 250 x 48° | 1,10 | - | 2 3/4 |
| 739 745 | 300 x 250 x 48° | 2,10 | 1300 | 2 3/4 |

LOPATA PREKOPNA SPATEN SPADE BËCHE



| Art. No. | (AxB) | | | <i>i</i> |
|----------|-----------|------|---|----------|
| 756 306 | 245 x 178 | 0,70 | - | - |
| 758 068 | 200 x 130 | 0,43 | - | - |

LOPATA PREKOPNA KONIČASTA FRANKFURTER SCHAUFEL SAND SHOVEL "FRANKFURTER" BËCHE



| Art. No. | (AxB) | | | <i>i</i> |
|----------|-----------|------|------|----------|
| 739 527 | 300 x 270 | 1,10 | - | - |
| 739 746 | 300 x 270 | 2,10 | 1300 | - |

LOPATA METAČA AUFBUGSCHAUFEL SHOVEL FOR THROWING PELLE



| Art. No. | (AxB) | | | <i>i</i> |
|----------|-----------|------|------|----------|
| 729 446 | 300 x 270 | 1,10 | - | - |
| 758 257 | 300 x 270 | 1,10 | - | PLITVA |
| 716 155 | 300 x 270 | 2,10 | 1300 | - |
| 758 258 | 300 x 270 | 2,10 | 1300 | PLITVA |

LOPATA KONIČASTA BLECH SPITZSCHAUFEL POINTED SHOVEL PELLE



| Art. No. | (AxB) | | | <i>i</i> |
|----------|-----------|------|-------|----------|
| 716 278 | 295 x 210 | 1,10 | - | - |
| 777 489 | 295 x 210 | 1,65 | 1000 | - |
| 776 061 | 295 x 210 | 1,65 | T850 | - |
| 759 388 | 295 x 210 | 1,65 | PD850 | - |

LOPATA RAVNA "0" "HOLSTEINER" SCHAUFEL "0" SHOVEL "HOLSTEIN" "0" PELLE



| Art. No. | (AxB) | | | <i>i</i> |
|----------|-----------|------|---|----------|
| 756 631 | 275 x 220 | 0,95 | - | - |

LOPATA "WEICHMACH" WEICHMACHER SPADE "WEICHMACH" PELLE



| Art. No. | (AxB) | | | <i>i</i> |
|----------|-----------|------|---|----------|
| 757 111 | 175 x 212 | 0,75 | - | - |

LOPATA ZA PESEK - RAVNA HOLSTEINER SCHAUFEL SHOVEL "HOLSTEIN" PELLE "HOLSTEIN"



| Art. No. | (AxB) | | | <i>i</i> |
|----------|-----------|------|------|----------|
| 754 085 | 265 x 245 | 1,00 | - | 2 1/2 |
| 739 525 | 265 x 245 | 1,00 | - | 2 3/4 |
| 759 302 | 265 x 245 | 1,15 | - | 2 3/4-0 |
| 754 111 | 280 x 260 | 1,15 | - | 3 1/2 |
| 754 110 | 280 x 260 | 1,15 | - | 3 3/4 |
| 739 744 | 265 x 245 | 2,00 | 1300 | 2 3/4 |
| 757 027 | 280 x 260 | 2,15 | 1300 | 3 3/4 |

LOPATA PREKOPNA KONIČASTA KABELGRABENSCHAUFEL SPADE BËCHE



| Art. No. | (AxB) | | | <i>i</i> |
|----------|-----------|------|---|----------|
| 757 007 | 300 x 170 | 1,00 | - | - |





MOTIKE
HAUEN
HOES





**MOTIKA POSAVSKA
HAUE "POSAVSKA"**

**HOE "POSAVSKA"
HOUE "POSAVSKA"**

| Art. No. | (AxB) |  |  | <i>i</i> |
|----------|-----------|---|---|----------|
| 716 007 | 185 x 170 | 0,70 | - | - |
| 716 020 | 205 x 190 | 1,00 | - | - |
| 756 625 | 185 x 170 | 1,70 | 1200 | - |
| 756 626 | 205 x 190 | 1,70 | 1200 | - |



**MOTIKA TOBAČNA
HAUE "TOBAČNA"**

**HOE "TOBAČNA"
HOUE "TOBAČNA"**

| Art. No. | (AxB) |  |  | <i>i</i> |
|----------|-----------|---|---|----------|
| 716 058 | 160 x 135 | 0,25 | - | - |
| 754 346 | 160 x 135 | 0,80 | 1250 | - |

**ROVNICA SRBSKA
HAUE "SRBSKA"**

**HOE "SRBSKA"
HOUE "SRBSKA"**

| Art. No. | (AxB) |  |  | <i>i</i> |
|----------|-----------|---|---|----------|
| 716 024 | 205 x 100 | 1,60 | - | - |
| 756 628 | 205 x 160 | 2,60 | 1100 | - |



**MOTIKA RUDARSKA
HAUE "RUDARSKA"**

**HOE "RUDARSKA"
HOUE "RUDARSKA"**

| Art. No. | (AxB) |  |  | <i>i</i> |
|----------|-----------|---|---|----------|
| 748 019 | 240 x 240 | 1,50 | - | - |



**MOTIKA BISTRIŠKA
HAUE "BISTRIŠKA"**

**HOE "BISTRIŠKA"
HOUE "BISTRIŠKA"**

| Art. No. | (AxB) |  |  | <i>i</i> |
|----------|-----------|--|--|----------|
| 773 470 | 190 x 220 | 1,00 | - | - |
| 754 352 | 190 x 220 | 1,70 | 1200 | - |



**MOTIKA CESTARSKA
HAUE "CESTARSKA"**

**HOE "CESTARSKA"
HOUE "CESTARSKA"**

| Art. No. | (AxB) |  |  | <i>i</i> |
|----------|-----------|--|--|----------|
| 748 020 | 390 x 120 | 1,50 | - | - |



**MOTIKA ŠTAJERSKA
HAUE "ŠTAJERSKA"**

**HOE "ŠTAJERSKA"
HOUE "ŠTAJERSKA"**

| Art. No. | (AxB) |  |  | <i>i</i> |
|----------|-----------|---|---|----------|
| 716 050 | 190 x 170 | 0,40 | - | - |
| 716 052 | 230 x 210 | 0,60 | - | - |
| 713 647 | 190 x 170 | 0,90 | 1200 | - |
| 713 965 | 230 x 210 | 1,10 | 1200 | - |

**ROVNICA MADŽARSKA
HAUE "MADŽARSKA"**

**HOE "MADŽARSKA"
HOUE "MADŽARSKA"**

| Art. No. | (AxB) |  |  | <i>i</i> |
|----------|-----------|---|---|----------|
| 716 022 | 160 x 120 | 1,20 | - | - |
| 754 353 | 160 x 120 | 2,20 | 1100 | - |



**MOTIKA DOLENJSKA
HAUE "DOLENJSKA"**

**HOE "DOLENJSKA"
HOUE "DOLENJSKA"**

| Art. No. | (AxB) |  |  | <i>i</i> |
|----------|-----------|---|---|----------|
| 716 016 | 185 x 165 | 0,55 | - | - |
| 716 017 | 200 x 190 | 0,70 | - | - |
| 738 306 | 200 x 190 | 1,70 | 1200 | - |
| 748 047 | 220 x 210 | 1,10 | - | - |
| 763 039 | 185 x 165 | 1,55 | 1200 | - |

**MOTIKA MADŽARSKA 1
HAUE "MADŽARSKA" 1**

**HOE "MADŽARSKA" 1
HOUE "MADŽARSKA" 1**

| Art. No. | (AxB) |  |  | <i>i</i> |
|----------|-----------|---|---|----------|
| 759 796 | 325 x 115 | 0,90 | - | - |

MOTIKA MADŽARSKA 2
HAUE "MADŽARSKA" 2

HOE "MADŽARSKA" 2
HOUE "MADŽARSKA" 2



| Art. No. | (AxB) | | | <i>i</i> |
|----------|-----------|------|---|----------|
| 759 797 | 115 x 115 | 0,25 | - | - |

MOTIKA SMEDEREVSKA
HAUE "SMEDEREVSKA"

HOE "SMEDEREVSKA"
HOUE "SMEDEREVSKA"



| Art. No. | (AxB) | | | <i>i</i> |
|----------|-----------|------|------|----------|
| 716 012 | 165 x 290 | 1,00 | - | - |
| 759 269 | 165 x 290 | 1,80 | 1200 | - |

MOTIKA MADŽARSKA 3
HAUE "MADŽARSKA" 3

HOE "MADŽARSKA" 3
HOUE "MADŽARSKA" 3



| Art. No. | (AxB) | | | <i>i</i> |
|----------|-----------|------|---|----------|
| 759 798 | 220 x 195 | 0,90 | - | - |

ROVNICA POŽAREVAČKA
HAUE "POŽAREVAČKA"

HOE "POŽAREVAČKA"
HOUE "POŽAREVAČKA"



| Art. No. | (AxB) | | | <i>i</i> |
|----------|-----------|------|---|----------|
| 716 013 | 150 x 330 | 1,00 | - | - |

MOTIKA NEMŠKA RUDARSKA
SPITZKRATZE

GERMAN HOE
HOUE



| Art. No. | (AxB) | | | <i>i</i> |
|----------|-----------|------|---|----------|
| 716 023 | 250 x 220 | 1,30 | - | - |

MOTIKA ŠABAČKA
HAUE "ŠABAČKA"

HOE "ŠABAČKA"
HOUE "ŠABAČKA"



| Art. No. | (AxB) | | | <i>i</i> |
|----------|-----------|------|---|----------|
| 716 010 | 190 x 250 | 0,80 | - | - |

MOTIKA "SCHWANBERG"
SCHWANBERGER HAUE

HOE "SCHWANBERG"
HOUE "SCHEANBERG"



| Art. No. | (AxB) | | | <i>i</i> |
|----------|-----------|------|------|----------|
| 755 603 | 180 x 160 | 0,30 | - | - |
| 755 604 | 190 x 170 | 0,40 | - | - |
| 755 605 | 200 x 190 | 0,50 | - | - |
| 755 606 | 220 x 200 | 0,60 | - | - |
| 757 942 | 180 x 160 | 0,90 | 1250 | - |
| 757 943 | 190 x 170 | 1,00 | 1250 | - |
| 757 944 | 200 x 190 | 1,10 | 1250 | - |
| 757 945 | 220 x 200 | 1,20 | 1250 | - |

MOTIKA GORNJE MILANOVAČKA
HAUE "GORNJE MILANOVAČKA"

HOE "GORNJE MILANOVAČKA"
HOUE "GORNJE MILANOVAČKA"



| Art. No. | (AxB) | | | <i>i</i> |
|----------|-----------|------|------|----------|
| 716 009 | 160 x 240 | 0,90 | - | - |
| 763 802 | 160 x 240 | 1,50 | 1200 | - |

MOTIKA KONGO
HAUE "KONGO"

HOE "KONGO"
HOUE "KONGO"



| Art. No. | (AxB) | | | <i>i</i> |
|----------|-----------|------|------|----------|
| 776 281 | 220 x 160 | 1,15 | - | - |
| 762 340 | 220 x 140 | 1,05 | - | - |
| 766 345 | 220 x 140 | 2,05 | 1200 | - |
| 757 353 | 220 x 160 | 2,15 | 1200 | - |
| 777 112 | 220 x 120 | 1,05 | - | - |
| 777 113 | 200 x 140 | 1,00 | - | - |
| 777 114 | 180 x 120 | 0,95 | - | - |

MOTIKA UŽIČKA
HAUE "UŽIČKA"

HOE "UŽIČKA"
HOUE "UŽIČKA"



| Art. No. | (AxB) | | | <i>i</i> |
|----------|-----------|------|---|----------|
| 716 030 | 195 x 220 | 0,80 | - | - |

MOTIKA PEČSKA
HAUE "PEČSKA" HOE "PEČSKA"
HOUE "PEČSKA"

| Art. No. | (AxB) | | | <i>i</i> |
|----------|-----------|------|---|----------|
| 748 013 | 200 x 290 | 1,00 | - | - |



MOTIKA STUPIŠKA
HAUE "STUPIŠKA" HOE "STUPIŠKA"
HOUE "STUPIŠKA"

| Art. No. | (AxB) | | | <i>i</i> |
|----------|-----------|------|------|----------|
| 748 041 | 150 x 220 | 1,00 | - | - |
| 756 621 | 150 x 220 | 1,70 | 1200 | - |



MOTIKA KOČANSKA
HAUE "KOČANSKA" HOE "KOČANSKA"
HOUE "KOČANSKA"

| Art. No. | (AxB) | | | <i>i</i> |
|----------|-----------|------|---|----------|
| 716 019 | 200 x 265 | 1,20 | - | - |
| 756 627 | 200 x 265 | 2,10 | - | - |



MOTIKA ZELINSKA
HAUE "ZELINSKA" HOE "ZELINSKA"
HOUE "ZELINSKA"

| Art. No. | (AxB) | | | <i>i</i> |
|----------|-----------|------|---|----------|
| 748 022 | 180 x 235 | 1,20 | - | - |



MOTIKA SKOPSKA
HAUE "SKOPSKA" HOE "SKOPSKA"
HOUE "SKOPSKA"

| Art. No. | (AxB) | | | <i>i</i> |
|----------|-----------|------|------|----------|
| 716 014 | 190 x 245 | 1,20 | - | - |
| 716 015 | 200 x 265 | 1,40 | - | - |
| 754 354 | 190 x 245 | 2,20 | 1200 | - |



MOTIKA GRANIČARSKA
HAUE "GRANIČARSKA" HOE "GRANIČARSKA"
HOUE "GRANIČARSKA"

| Art. No. | (AxB) | | | <i>i</i> |
|----------|-----------|------|---|----------|
| 716 006 | 170 x 210 | 0,90 | - | - |
| 756 623 | 170 x 210 | 1,70 | - | - |



MOTIKA BITOLSKA
HAUE "BITOLSKA" HOE "BITOLSKA"
HOUE "BITOLSKA"

| Art. No. | (AxB) | | | <i>i</i> |
|----------|-----------|------|------|----------|
| 716 003 | 180 x 180 | 0,50 | - | - |
| 716 011 | 195 x 200 | 0,70 | - | - |
| 716 040 | 220 x 240 | 1,00 | - | - |
| 756 619 | 180 x 180 | 1,50 | 1300 | - |
| 754 347 | 195 x 200 | 1,70 | 1300 | - |



MOTIKA LIŠKA
HAUE "LIŠKA" HOE "LIŠKA"
HOUE "LIŠKA"

| Art. No. | (AxB) | | | <i>i</i> |
|----------|-----------|------|---|----------|
| 748 043 | 150 x 220 | 1,00 | - | - |



MOTIKA TOPLIŠKA
HAUE "TOPLIŠKA" HOE "TOPLIŠKA"
HOUE "TOPLIŠKA"

| Art. No. | (AxB) | | | <i>i</i> |
|----------|-----------|------|---|----------|
| 716 043 | 190 x 260 | 0,80 | - | - |



MOTIKA BIHAČKA
HAUE BIHAČKA HOE "BIHAČKA"
HOUE "BIHAČKA"

| Art. No. | (AxB) | | | <i>i</i> |
|----------|-----------|------|------|----------|
| 716 049 | 140 x 270 | 0,80 | - | - |
| 764 458 | 140 x 270 | 1,30 | 1250 | - |



MOTIKA BOSANSKA
HAUE "BOSANSKA"

HOE "BOSANSKA"
HOUE "BOSANSKA"



| Art. No. | (AxB) | | | <i>i</i> |
|----------|-----------|------|------|----------|
| 716 008 | 140 x 280 | 0,70 | - | - |
| 764 459 | 140 x 180 | 1,45 | 1200 | - |

MOTIKA GROTSKA
HAUE "GROTSKA"

HOE "GROTSKA"
HOUE "GROTSKA"



| Art. No. | (AxB) | | | <i>i</i> |
|----------|-----------|------|------|----------|
| 748 033 | 190 x 265 | 0,80 | - | - |
| 754 351 | 190 x 265 | 1,80 | 1200 | - |

MOTIKA FOČANSKA
HAUE "FOČANSKA"

HOE "FOČANSKA"
HOUE "FOČANSKA"



| Art. No. | (AxB) | | | <i>i</i> |
|----------|-----------|------|------|----------|
| 716 001 | 220 x 210 | 0,80 | - | - |
| 763 795 | 220 x 210 | 1,80 | 1200 | - |

MOTIČICA TOBAČNA OKROGLA
HAUE "TOBAČNA OKROGLA"

HOE "TOBAČNA OKROGLA"
HOUE "TOBAČNA OKROGLA"



| Art. No. | (AxB) | | | <i>i</i> |
|----------|-----------|------|---|----------|
| 716 059 | 120 x 150 | 0,30 | - | - |
| 756 620 | 120 x 150 | 0,80 | - | - |

MOTIKA NIKŠIČKA
HAUE "NIKŠIČKA"

HOE "NIKŠIČKA"
HOUE "NIKŠIČKA"



| Art. No. | (AxB) | | | <i>i</i> |
|----------|-----------|------|------|----------|
| 716 002 | 195 x 250 | 1,00 | - | - |
| 737 956 | 195 x 200 | 2,00 | 1200 | - |

MOTIKA KUTINSKA
HAUE "KUTINSKA"

HOE "KUTINSKA"
HOUE "KUTINSKA"



| Art. No. | (AxB) | | | <i>i</i> |
|----------|-----------|------|---|----------|
| 716 005 | 150 x 300 | 0,90 | - | - |
| 756 624 | 150 x 300 | 1,70 | - | - |

MOTIKA LJUTOMERSKA
HAUE "LJUTOMERSKA"

HOE "LJUTOMERSKA"
HOUE "LJUTOMERSKA"



| Art. No. | (AxB) | | | <i>i</i> |
|----------|-----------|------|------|----------|
| 716 053 | 290 x 260 | 1,40 | - | - |
| 756 575 | 290 x 260 | 2,40 | 1200 | - |

MOTIKA PRISTAVSKA
HAUE "PRISTAVSKA"

HOE "PRISTAVSKA"
HOUE "PRISTAVSKA"



| Art. No. | (AxB) | | | <i>i</i> |
|----------|-----------|------|------|----------|
| 716 995 | 230 x 260 | 1,40 | - | - |
| 754 348 | 230 x 260 | 2,20 | 1200 | - |

MOTIKA RADGONSKA
HAUE "RADGONSKA"

HOE "RADGONSKA"
HOUE "RADGONSKA"



| Art. No. | (AxB) | | | <i>i</i> |
|----------|-----------|------|------|----------|
| 748 031 | 240 x 220 | 0,80 | - | - |
| 756 574 | 240 x 220 | 1,80 | 1300 | - |

MOTIKA IMOTSKA
HAUE "IMOTSKA"

HOE "IMOTSKA"
HOUE "IMOTSKA"



| Art. No. | (AxB) | | | <i>i</i> |
|----------|-----------|------|---|----------|
| 757 013 | 225 x 230 | 1,20 | - | - |



GRABLJE, STRGALA IN GREBLJICE, VRTNO IN CVETLIČNO ORODJE
RECHEN, HACKEN UND KRATZER, BLUMEN GERÄTE UND GARTEN GERÄTE
RAKES, POKER AND SCRAPER, FLOWER AND GARDEN TOOLS



**GRABLJE VRTNE
GARTENRECHEN** **GARDEN RAKE
RÂTEAU DE JARDIN**

| Art. No. | (AxBxC) | | | <i>i</i> |
|----------|------------------|------|------|----------|
| 731 359 | 8Z 197 x 80 x 5 | 0,30 | - | ø24 |
| 731 360 | 10Z 251 x 80 x 5 | 0,40 | - | ø24 |
| 731 357 | 8Z 197 x 80 x 5 | 0,85 | 1500 | ø24 |
| 731 358 | 10Z 251 x 80 x 5 | 0,95 | 1500 | ø24 |

**GRABLJE Z NASADILOM
RECHEN MIT STIFT** **RAKE WITH TANG
RÂTEAU**

| Art. No. | (AxBxC) | | | <i>i</i> |
|----------|------------------|------|---|----------|
| 759 207 | 8Z 197 x 85 x 5 | 0,28 | - | N3 |
| 759 208 | 10Z 250 x 85 x 5 | 0,35 | - | N3 |
| 759 391 | 12Z 305 x 85 x 5 | 0,42 | - | N3 |
| 757 875 | 14Z 360 x 85 x 5 | 0,49 | - | N3 |
| 757 876 | 16Z 413 x 85 x 5 | 0,56 | - | N3 |

**GRABLJE VRTNE
GARTENRECHEN** **GARDEN RAKE
RÂTEAU DE JARDIN**

| Art. No. | (AxBxC) | | | <i>i</i> |
|----------|------------------|------|------|----------|
| 731 361 | 12Z 305 x 80 x 5 | 0,50 | - | ø28 |
| 731 362 | 14Z 360 x 80 x 5 | 0,60 | - | ø28 |
| 731 363 | 16Z 413 x 80 x 5 | 0,70 | - | ø28 |
| 731 354 | 12Z 305 x 80 x 5 | 1,25 | 1500 | ø28 |
| 731 355 | 14Z 360 x 80 x 5 | 1,35 | 1500 | ø28 |
| 731 356 | 16Z 413 x 80 x 5 | 1,45 | 1500 | ø28 |

**GRABLJE Z NASADILOM IN NOSILCEM
RECHEN MIT STIFT UND TREGER** **RAKE WITH TANG
RÂTEAU**

| Art. No. | (AxBxC) | | | <i>i</i> |
|----------|------------------|------|---|----------|
| 757 633 | 14Z 360 x 85 x 5 | 0,67 | - | N6 |

**GRABLJE VRTNE
GARTENRECHEN** **GARDEN RAKE
RÂTEAU DE JARDIN**

| Art. No. | (AxBxC) | | | <i>i</i> |
|----------|------------------|------|------|----------|
| 716 137 | 18Z 467 x 80 x 5 | 0,80 | - | ø28 |
| 716 139 | 20Z 520 x 80 x 5 | 0,90 | - | ø28 |
| 731 267 | 18Z 467 x 80 x 5 | 1,55 | 1500 | ø28 |
| 731 268 | 20Z 520 x 80 x 5 | 1,65 | 1500 | ø28 |

**GRABLJE Z NASADILOM IN NOSILCEM
RECHEN MIT STIFT UND TREGER** **RAKE WITH TANG
RÂTEAU**

| Art. No. | (AxBxC) | | | <i>i</i> |
|----------|------------------|------|---|----------|
| 757 640 | 14Z 360 x 85 x 5 | 0,80 | - | N3 |
| 757 872 | 16Z 413 x 85 x 5 | 0,81 | - | N3 |

**GRABLJE VRTNE
GARTENRECHEN** **GARDEN RAKE
RÂTEAU DE JARDIN**

| Art. No. | (AxBxC) | | | <i>i</i> |
|----------|------------------|------|------|----------|
| 711 760 | 30Z 590 x 62 x 3 | 0,55 | - | ø24 |
| 779 254 | 30Z 590 x 62 x 3 | 1,10 | 1500 | ø28 |

**CESTARSKE LAHKE UPOGNIJENE
STRABENRECHEN LEICHT GEBOGEN** **ROAD RAKE LIGHT
RÂTEAU FORGÉ**

| Art. No. | (AxBxC) | | | <i>i</i> |
|----------|------------------|------|---|----------|
| 762 150 | 12Z 305 x 80 x 5 | 0,42 | - | D26 |
| 762 151 | 14Z 360 x 80 x 5 | 0,49 | - | D26 |
| 762 152 | 16Z 413 x 80 x 5 | 0,56 | - | D26 |

**GRABLJE VRTNE Z NASADILOM
GARTENRECHEN MIT STIFT** **GARDEN RAKE
RÂTEAU**

| Art. No. | (AxBxC) | | | <i>i</i> |
|----------|------------------|------|------|----------|
| 759 206 | 8Z 197 x 80 x 5 | 0,28 | - | N3 |
| 759 063 | 10Z 250 x 80 x 5 | 0,35 | - | N3 |
| 759 064 | 12Z 305 x 80 x 5 | 0,42 | - | N3 |
| 759 065 | 14Z 360 x 80 x 5 | 0,49 | - | N3 |
| 759 066 | 16Z 413 x 80 x 5 | 0,56 | - | N3 |
| 762 228 | 14Z 360 x 80 x 5 | 1,30 | 1700 | N3 |

**CESTARSKE LAHKE RAVNE
STRABENRECHEN LEICHT GERADE** **ROAD RAKE
RÂTEAU FORGÉ**

| Art. No. | (AxBxC) | | | <i>i</i> |
|----------|------------------|------|---|----------|
| 762 153 | 12Z 305 x 85 x 5 | 0,42 | - | D26 |
| 762 154 | 14Z 360 x 85 x 5 | 0,49 | - | D26 |
| 762 155 | 16Z 413 x 85 x 5 | 0,56 | - | D26 |

**GRABLJE Z NASADILOM
RECHEN MIT STIFT** **RAKE WITH TANG
RÂTEAU**

| Art. No. | (AxBxC) | | | <i>i</i> |
|----------|-------------------|------|---|----------|
| 757 688 | 10Z 205 x 85 x 5 | 0,37 | - | N6 |
| 756 482 | 12Z 305 x 85 x 5 | 0,44 | - | N6 |
| 756 483 | 14Z 360 x 85 x 5 | 0,51 | - | N6 |
| 756 484 | 16Z 413 x 85 x 5 | 0,58 | - | N6 |
| 758 615 | 10Z 205 x 85 x 5K | 0,37 | - | N6 |
| 758 616 | 12Z 305 x 85 x 5K | 0,44 | - | N6 |
| 758 617 | 14Z 360 x 85 x 5K | 0,51 | - | N6 |
| 758 618 | 16Z 413 x 85 x 5K | 0,58 | - | N6 |

**GRABLJE CESTARSKE LAHKE
STRABENRECHEN LEICHT** **ROAD RAKE LIGHT
RÂTEAU FORGÉ**

| Art. No. | (AxBxC) | | | <i>i</i> |
|----------|-------------------|------|------|----------|
| 716 144 | 8Z 197 x 80 x 5 | 0,35 | - | D26 |
| 716 145 | 10Z 251 x 80 x 5 | 0,45 | - | D26 |
| 752 898 | 12Z 305 x 80 x 5 | 0,50 | - | D26 |
| 752 899 | 14Z 306 x 80 x 5 | 0,55 | - | D26 |
| 752 900 | 16Z 413 x 80 x 5 | 0,65 | - | D26 |
| 763 752 | 18Z 467 x 80 x 5 | 0,59 | - | - |
| 764 085 | 14Z 360 x 80 x 5 | 1,00 | 1500 | - |
| 758 595 | 8Z 197 x 80 x 5K | 0,35 | - | D26 |
| 758 590 | 10Z 251 x 80 x 5K | 0,45 | - | D26 |
| 758 597 | 12Z 305 x 80 x 5K | 0,50 | - | D26 |
| 758 598 | 14Z 306 x 80 x 5K | 0,55 | - | D26 |
| 758 599 | 16Z 413 x 80 x 5K | 0,65 | - | D26 |
| 765 729 | 14Z 306 x 80 x 5K | 1,00 | 1500 | - |
| 765 730 | 16Z 413 x 80 x 5K | 1,10 | 1500 | - |

GRABLJE CESTARSKÉ - TEŽKÉ
STRABENRECHEN SCHWER

ROAD RAKE HEAVY
RÂTEAU FORGÉ À CAILLOUTIS



| Art. No. | | (AxBxC) | | | | <i>i</i> |
|----------|-----|----------------|------|------|-----|----------|
| 753 114 | 10Z | 320 x 120 x 5 | 0,85 | - | ø35 | |
| 739 969 | 12Z | 390 x 120 x 5 | 1,00 | - | ø35 | |
| 752 430 | 14Z | 456 x 120 x 5 | 1,11 | - | ø35 | |
| 752 901 | 16Z | 524 x 120 x 5 | 1,27 | - | ø35 | |
| 764 088 | 14Z | 456 x 120 x 5 | 2,00 | 1500 | - | |
| 758 649 | 10Z | 320 x 120 x 5K | 0,85 | - | ø35 | |
| 758 650 | 12Z | 390 x 120 x 5K | 1,00 | - | ø35 | |
| 758 651 | 14Z | 456 x 120 x 5K | 1,11 | - | ø35 | |
| 758 652 | 16Z | 524 x 120 x 5K | 1,27 | - | ø35 | |

GRABLJE REZILNE
RASENLÜFTER

LAWN RAKE
SCARIFICATEUR



| Art. No. | | (AxBxC) | | | | <i>i</i> |
|----------|-----|---------------|------|------|---|----------|
| 756 480 | 14Z | 382 x 100 x 3 | 0,81 | - | - | |
| 756 894 | 14Z | 382 x 100 x 3 | 1,46 | 1500 | - | |

GRABLJE Z NOSILCEM ENOJNIM
MISCHGUTRECHEN

RAKE WITH HOLDER
RÂTEAU



| Art. No. | | (AxBxC) | | | | <i>i</i> |
|----------|-----|--------------|------|---|---|----------|
| 753 779 | 14Z | 386 x 90 x 5 | 1,00 | - | - | |
| 753 298 | 16Z | 444 x 90 x 5 | 1,00 | - | - | |

GRABLJE CVETLIČNE
BLUMENRECHEN

FLOWER RAKE
RÂTEAU



| Art. No. | | (AxBxC) | | | | <i>i</i> |
|----------|-----|--------------|------|---|---|----------|
| 759 606 | 10Z | 243 x 70 x 3 | 0,25 | - | - | |

GRABLJE Z NOSILCEM DVOJNIM
MISCHGUTRECHEN

ASPHALT RAKE
RÂTEAU



| Art. No. | | (AxBxC) | | | | <i>i</i> |
|----------|-----|--------------|------|---|---|----------|
| 753 299 | 16Z | 444 x 90 x 5 | 1,20 | - | - | |

GREBLJICA ZA MALTO
KOTKRÜCKE

MORTAR SCRAPER
RACLOIR



| Art. No. | | (AxB) | | | | <i>i</i> |
|----------|--|-----------|------|------|---|----------|
| 716 102 | | 270 x 120 | 0,80 | - | - | |
| 744 189 | | 270 x 120 | 1,80 | 1300 | - | |

GRABLJE CESTARSKÉ Z JARMOM
TEERRECHEN

TARMAC RAKE
RÂTEAU FORGÉ



| Art. No. | | (AxBxC) | | | | <i>i</i> |
|----------|-----|---------------|------|------|---|----------|
| 756 470 | 14Z | 390 x 82 x 25 | 1,55 | - | - | |
| 756 473 | 14Z | 390 x 82 x 25 | 2,65 | 1320 | - | |
| 756 472 | 14Z | 390 x 82 x 25 | 2,60 | 1330 | - | |

GREBLJICA CESTARSKA
KOTKRÜCKE

ROAD SCRAPER
RACLOIR



| Art. No. | | (AxB) | | | | <i>i</i> |
|----------|--|-----------|------|------|---|----------|
| 724 788 | | 300 x 110 | 0,90 | - | - | |
| 724 787 | | 345 x 110 | 1,00 | - | - | |
| 762 962 | | 300 x 110 | 1,90 | 1300 | - | |
| 766371 | | 345 x 110 | 2,00 | 1300 | - | |

GRABLJE ZA ASFALT
TEERRECHEN

ASPHALT RAKE
RÂTEAU FORGÉ



| Art. No. | | (AxBxC) | | | | <i>i</i> |
|----------|-----|--------------|------|------|---|----------|
| 756 476 | 16Z | 440 x 90 x 6 | 1,30 | - | - | |
| 756 479 | 16Z | 440 x 90 x 6 | 1,45 | 1320 | - | |
| 756 478 | 16Z | 440 x 90 x 6 | 2,40 | 1330 | - | |

GREBLJICA OKROGLA
SCHUFFEL

SCRAPER
RASETTE



| Art. No. | | (AxB) | | | | <i>i</i> |
|----------|--|----------|------|---|---|----------|
| 759 500 | | 140 x 45 | 0,42 | - | - | |
| 759 501 | | 160 x 45 | 0,43 | - | - | |
| 759 502 | | 180 x 45 | 0,44 | - | - | |
| 759 503 | | 200 x 45 | 0,45 | - | - | |

GRABLJE CESTARSKÉ ZA ASFALT
TEERRECHEN

ASPHALT RAKE
RÂTEAU



| Art. No. | | (AxBxC) | | | | <i>i</i> |
|----------|-----|--------------|------|---|---|----------|
| 752 902 | 16Z | 413 x 85 x 5 | 1,70 | - | - | |

GREBLJICA ORMOŠKA
UNKRAUTHACKE "ORMOŠKA"

SCRAPER "ORMOŠKA"
RASETTE "ORMOŠKA"



| Art. No. | | (AxB) | | | | <i>i</i> |
|----------|--|----------|------|------|---|----------|
| 776 060 | | 180 x 70 | 0,35 | - | - | |
| 716 158 | | 180 x 70 | 0,80 | 1400 | - | |

GREBLJICA FRANCOSKA
UNKRAUTHACKE "FRANCOSKA"

SCRAPER "FRANCOSKA"
BINETTE "FRANCOSKA"



| Art. No. | (A x B) | | | i |
|----------|-----------|------|------|---|
| 721 566 | 160 x 100 | 0,40 | - | - |
| 744 190 | 160 x 100 | 0,75 | 1100 | - |
| 752 973 | 160 x 100 | 0,80 | 1400 | - |
| 755 431 | 140 x 100 | - | - | - |

ČRTALO ZA VRSTE
RILLENZIEHER

PULLER LINE ADJUSTABLE
SILLONNEUR RÉGLABLES



| Art. No. | (A x B) | | | i |
|----------|-----------|------|-----|---|
| 716 247 | 670 x 150 | 1,40 | - | - |
| 776 178 | 670 x 150 | 2,35 | 150 | - |

STRGALO ZA CENTRALNO PEČ
CENTRALHEIZUNG KRATZER

CENTRAL HEATING SCRAPER
GRATTOIR



| Art. No. | (A x B) | | | i |
|----------|----------|------|---|---|
| 716 162 | 150 x 58 | 0,80 | - | - |

STRGALO SRČASTO
SCHUFFEL

SCUFFLE HOE
RASETTE HOLLANDAISE



| Art. No. | (A x B) | | | i |
|----------|----------|------|---|---|
| 759 408 | 160 x 83 | 0,40 | - | - |
| 759 409 | 200 x 83 | 0,45 | - | - |

STRGALO TOGO
BÜGELJÄTER

PULL HOE
RASETTE Á TIRER



| Art. No. | (A x B) | | | i |
|----------|----------|------|------|---|
| 716 280 | 160 x 40 | 0,40 | - | - |
| 776 166 | 160 x 40 | 0,80 | 1400 | - |

MOTIČICA CVETLIČNA
KLEINHACKE

FLOWER HOE
SERFOUETTE

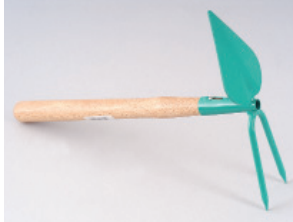

| Art. No. | (A x B) | | | i |
|----------|----------|------|-----|---|
| 721 182 | 190 x 60 | 0,13 | - | - |
| 716 254 | 190 x 60 | 0,20 | 300 | - |

STRGALO TOGO "F"
BÜGELJÄTER F

WEED CUTER F
GRATTOIR DE JARDIN



| Art. No. | (A x B) | | | i |
|----------|-----------|------|------|---|
| 774 811 | 160 x 120 | 0,30 | - | - |
| 776 167 | 160 x 120 | 0,75 | 1400 | - |

GRABEŽ PLEVELA
GRUBBER

WEED RAKE
GRIFFE



| Art. No. | (A x B) | | | i |
|----------|---------|------|-----|---|
| 739 373 | 75 x 85 | 0,06 | - | - |
| 716 243 | 75 x 85 | 0,11 | 160 | - |

STRGALO POMIČNO
PENDELJÄTER

MOVE SCRAPER
SUBRA CLETTE



| Art. No. | (A x B) | | | i |
|----------|-----------|------|------|---|
| 716 281 | 160 x 120 | 0,50 | - | - |
| 776 176 | 160 x 120 | 1,25 | 1500 | - |

KLIN SADILNI
STAHLPLANCER

DIBBER
PLANTOIR



| Art. No. | (A x B) | | | i |
|----------|----------|------|------|---|
| 716 242 | 200 x 40 | 0,20 | K100 | - |
| 763 838 | 175 x 40 | 0,30 | - | - |

STRGALO ZA BLATO
SCHUFFEL

SCUFFLE HOE
RASETTE



| Art. No. | (A x B) | | | i |
|----------|----------|------|---|---|
| 758 563 | 140 x 56 | 0,38 | - | - |
| 758 564 | 160 x 56 | 0,40 | - | - |
| 758 565 | 180 x 56 | 0,45 | - | - |
| 758 566 | 200 x 56 | 0,50 | - | - |

MOTIČICA CVETLIČNA RAVNA
KLEINHACKE

FLOWER HOE - FLAT
SERFOUETTE



| Art. No. | (A x B) | | | i |
|----------|----------|------|-----|---|
| 739 369 | 185 x 50 | 0,13 | - | - |
| 716 253 | 185 x 50 | 0,20 | 300 | - |

RAHLJAČ CVETLIČNI GRUBBER **FLOWER TORMENTOR GRIFFE**

| Art. No. | (A x B) | | | <i>i</i> |
|----------|----------|------|-----|----------|
| | | | | |
| 739 371 | 70 x 100 | 0,10 | - | - |
| 716 244 | 70 x 100 | 0,17 | 300 | - |

METLA ŽIČNA 35 LAUBRECHEN 35 DRAHT **LAWN RAKE 35 WIRE BALAI**

| Art. No. | (A x B) | | | <i>i</i> |
|----------|-----------|------|------|----------|
| | | | | |
| 764 000 | 350 x 300 | 0,45 | - | - |
| 763 980 | 350 x 300 | 0,90 | 1300 | - |

LOPATICA CVETLIČNA BLUMENKELLE **TROWEL TRANPLANTOIR**

| Art. No. | (A x B) | | | <i>i</i> |
|----------|-----------|------|-----|----------|
| | | | | |
| 763 839 | 280 x 125 | 0,25 | 100 | - |
| 716 241 | 280 x 125 | 0,20 | 100 | - |

METLA ŽIČNA 50 LAUBRECHEN 50 DRAHT **LAWN RAKE 50 WIRE BALAI**

| Art. No. | (A x B) | | | <i>i</i> |
|----------|-----------|------|------|----------|
| | | | | |
| 764 003 | 500 x 400 | 0,65 | - | - |
| 763 981 | 500 x 400 | 1,10 | 1300 | - |

METLIČA ŽIČNA DRATHHANDFEGER **WIRED BROOM RÂTEAU**

| Art. No. | (A x B) | | | <i>i</i> |
|----------|-----------|------|-----|----------|
| | | | | |
| 716 263 | 130 x 200 | 0,25 | 100 | - |

METLA PERESNA FIKSNA LAUBRECHEN FEST **LAWN RAKE FIXED BALAI**

| Art. No. | (A x B) | | | <i>i</i> |
|----------|-----------|------|------|----------|
| | | | | |
| 764 008 | 450 x 350 | 0,60 | - | - |
| 763 982 | 450 x 350 | 1,05 | 1300 | - |

GRABLJICE CVETLIČNE 6Z KLEINRECHEN **FLOWER RAKE RÂTEAU**

| Art. No. | (A x B) | | | <i>i</i> |
|----------|----------|------|-----|----------|
| | | | | |
| 738 945 | 108 x 65 | 0,13 | - | - |
| 772 247 | 108 x 65 | 0,20 | 300 | - |

METLA PERESNA NASTAVLJIVA LAUBRECHEN VERSTELLBAR **LAWN RAKE ADJUSTABLE BALAI**

| Art. No. | (A x B) | | | <i>i</i> |
|----------|---------------|------|------|----------|
| | | | | |
| 764 005 | 310-540 x 350 | 0,65 | - | - |
| 763 983 | 310-540 x 350 | 1,10 | 1300 | - |

SADILEC ČEBULIC BLUMENZWIEBEL PFLANZER **BULB PLANER PLANTOIR Á BULBES**

| Art. No. | (A x B) | | | <i>i</i> |
|----------|----------|------|---|----------|
| | | | | |
| 775 512 | 70 x 240 | 0,25 | - | - |

ČISTILEC ČEVLJEV SCHUHPUTZER **SHOE CLINER SERFOUETTE**

| Art. No. | (A x B) | | | <i>i</i> |
|----------|-----------|------|-----|----------|
| | | | | |
| 758 582 | 180 x 180 | 2,54 | 850 | - |

GREBLJICA CVETLIČNA BLUMENHACKE **GARDEN PULL HOE RASETTE**

| Art. No. | (A x B) | | | <i>i</i> |
|----------|---------|------|-----|----------|
| | | | | |
| 738 944 | 60 x 40 | 0,13 | - | - |
| 774 764 | 60 x 40 | 0,20 | 300 | - |

KOMPLETI SATZ **SUIT TROUSSE**

| | | | |
|---------|---|--|----------------------|
| | | | |
| 777 727 | 716241+716243+772247 | | KPL.5 |
| 776 340 | 716241+716242+716253+772247 | | KPL.6 |
| 776 341 | 716241+716242+716243+772247 | | KPL.8 |
| 726 580 | 724772+724769+724754+724756+724758+724764 | | KPL. Otroški program |

LOPATICA KONIČASTA METAČA
KINDER SPITZSCHAUFEL

THROWING SHOVEL - TIPPED
PELLE



| Art. No. | (AxB) | | | <i>i</i> |
|----------|-----------|------|-----|----------|
| 724 753 | 145 x 145 | 0,18 | - | - |
| 724 754 | 145 x 145 | 0,40 | 760 | - |

MOTIČICA RAVNA F 3R
KINDER GARTENHACKE

HOE FLAT
SERFOUETTE



| Art. No. | (AxB) | | | <i>i</i> |
|----------|----------|------|-----|----------|
| 724 771 | 178 x 60 | 0,20 | - | - |
| 724 772 | 178 x 60 | 0,42 | 760 | - |

LOPATICA RAVNA METAČA
KINDERSCHAUFEL

THROWING SHOVEL - FLAT
PELLE



| Art. No. | (AxB) | | | <i>i</i> |
|----------|-----------|------|-----|----------|
| 724 755 | 132 x 117 | 0,19 | - | - |
| 724 756 | 132 x 117 | 0,41 | 760 | - |

MOTIČICA VRTNA KONIČASTA
GARTENHACKE, MIT HERZBLATT

SMALL GARDEN HOE
SERFOUETTE



| Art. No. | (AxB) | | | <i>i</i> |
|----------|----------|------|------|----------|
| 750 555 | 230 x 80 | 0,25 | - | ø24 |
| 755 016 | 230 x 80 | 0,45 | 750 | ø24 |
| 755 045 | 230 x 80 | 0,50 | 1100 | ø24 |
| 755 017 | 230 x 80 | 0,55 | 1400 | ø24 |
| 749 357 | 240 x 80 | 0,25 | - | ø21 |
| 776 066 | 240 x 80 | 0,45 | 750 | ø21 |
| 776 067 | 240 x 80 | 0,50 | 1100 | ø21 |
| 776 080 | 240 x 80 | 0,55 | 1400 | ø21 |

LOPATICA RAVNA PREKOPNA
KINDERSPATEN

DIGGING SHOVEL
BÉCHE



| Art. No. | (AxB) | | | <i>i</i> |
|----------|-----------|------|-----|----------|
| 724 757 | 145 x 120 | 0,16 | - | - |
| 724 758 | 145 x 120 | 0,38 | 760 | - |

MOTIČICA VRTNA RAVNA
GARTENHACKE, MIT RECHTECKBLATT

SMALL GARDEN HOE
SERFOUETTE



| Art. No. | (AxB) | | | <i>i</i> |
|----------|----------|------|------|----------|
| 772 242 | 220 x 65 | 0,25 | - | ø24 |
| 775 018 | 220 x 65 | 0,45 | 750 | ø24 |
| 775 046 | 220 x 65 | 0,50 | 1100 | ø24 |
| 775 019 | 220 x 65 | 0,55 | 1400 | ø24 |
| 772 243 | 230 x 65 | 0,25 | - | ø21 |
| 776 069 | 230 x 65 | 0,50 | 1100 | ø21 |

RAHLJAČ
KINDER GRUBBER

TORMENTOR
GRIFFE



| Art. No. | (AxB) | | | <i>i</i> |
|----------|---------|------|-----|----------|
| 724 768 | 70 x 75 | 0,14 | - | - |
| 724 769 | 70 x 75 | 0,36 | 760 | - |

MOTIČICA VRTNA
GARTENHACKE, MIT RECHTECKBLATT

SMALL GARDEN HOE
SERFOUETTE



| Art. No. | (AxB) | | | <i>i</i> |
|----------|----------|-------|------|----------|
| 773 604 | 265 x 80 | 0,305 | - | ø21 |
| 776 073 | 265 x 80 | 0,55 | 1100 | ø21 |

GRABLJICE F 8Z
KINDER RECHEN

RAKE
RÂTEU



| Art. No. | (AxB) | | | <i>i</i> |
|----------|----------|------|-----|----------|
| 724 763 | 148 x 62 | 0,16 | - | - |
| 724 764 | 148 x 62 | 0,38 | 760 | - |

KULTIVATOR 3 KOV.
KULTIVATOR

CULTIVATOR
CULTIVATEUR



| Art. No. | (AxB) | | | <i>i</i> |
|----------|-----------|------|-----|----------|
| 716 248 | 100 x 130 | 0,35 | - | - |
| 776 177 | 100 x 130 | 0,80 | 140 | - |



ZIMSKI PROGRAM
WINTER PROGRAMM
WINTER PROGRAMME



LOPATA SNEŽNA 400 S TULJAVO
SCHNEESCHAUFEL 400 MIT DÜLLE

SNOW SHOVEL
POUSSOIR À NEIGE



| Art. No. | (AxB) | | | i |
|----------|--------------|------|------|---|
| 748 990 | 350 x 400 AL | 1,20 | - | - |
| 776 165 | 350 x 400 AL | 1,90 | 1300 | - |

LOPATA SNEŽNA 500 S TULJAVO
SCHNEESCHIEBER MIT DÜLLE

SNOW SHOVEL
POUSSOIR À NEIGE



| Art. No. | (AxB) | | | i |
|----------|--------------|------|------|---|
| 758 545 | 350 x 500 AL | 1,40 | - | - |
| 716 245 | 350 x 500 AL | 2,10 | 1250 | - |

LOPATA SNEŽNA 400 Z VIJAKI
SCHNEESCHAUFEL 400 MIT SCHRAUBEN

SNOW SHOVEL
POUSSOIR À NEIGE



| Art. No. | (AxB) | | | i |
|----------|--------------|------|------|---|
| 758 547 | 350 x 400 AL | 1,00 | - | - |
| 758 468 | 350 x 400 AL | 1,70 | 1300 | - |

LOPATA SNEŽNA 500 Z VIJAKI
SCHNEESCHIEBER MIT SCHRAUBEN

SNOW SHOVEL
POUSSOIR À NEIGE



| Art. No. | (AxB) | | | i |
|----------|--------------|------|------|---|
| 758 549 | 350 x 500 AL | 1,20 | - | - |
| 758 466 | 350 x 500 AL | 1,90 | 1250 | - |

LOPATA SNEŽNA 400 S SPONKO
SCHNEESCHAUFEL 400 MIT KLEMMFIX

SNOW SHOVEL
POUSSOIR À NEIGE



| Art. No. | (AxB) | | | i |
|----------|--------------|------|------|---|
| 758 551 | 350 x 400 AL | 1,00 | - | - |
| 758 469 | 350 x 400 AL | 1,70 | 1250 | - |

LOPATA SNEŽNA 500 S SPONKO
SCHNEESCHIEBER MIT KLEMMFIX

SNOW SHOVEL
POUSSOIR À NEIGE



| Art. No. | (AxB) | | | i |
|----------|--------------|------|------|---|
| 758 553 | 350 x 500 AL | 1,20 | - | - |
| 758 467 | 350 x 500 AL | 1,90 | 1250 | - |

LOPATA ALU-9
ALU SCHAUFEL NR.9

ALUMINIUM SHOVEL NR.9
PELLE ALUMINIUM



| Art. No. | (AxB) | | | i |
|----------|--------------|------|------|---|
| 779 196 | 390 x 380 AL | 1,05 | - | - |
| 779 481 | 390 x 380 AL | 2,00 | 1300 | - |

LOPATA SNEŽNA 60
SCHNEESCHIEBER

SNOW SHOVEL
POUSSOIR À NEIGE



| Art. No. | (AxB) | | | i |
|----------|--------------|------|------|---|
| 758 933 | 335 x 465 AL | 0,60 | - | - |
| 759 049 | 335 x 465 AL | 1,20 | 1500 | - |

LOPATA ALU-7
ALU SCHAUFEL NR.7

ALUMINIUM SHOVEL NR.7
PELLE ALUMINIUM



| Art. No. | (AxB) | | | i |
|----------|--------------|------|------|---|
| 759 971 | 350 x 325 AL | 0,95 | - | - |
| 762 347 | 350 x 325 AL | 1,80 | 1300 | - |

LOPATA SNEŽNA PONVASTA
SCHNEESCHAUFEL

SNOW SHOVEL
PELLES À NEIGE



| Art. No. | (AxB) | | | i |
|----------|-----------|------|------|---|
| 763417 | 410 x 310 | 0,90 | - | - |
| 763422 | 410 x 310 | 1,85 | 1300 | - |

LOPATA ALU-9 Z ALUMINIJASTIM
ERGONOMSKIM ROČAJEM
ALU SCHAUFEL NR.9 MIT
ERGONOMISCHEM ALU STIEL

ALUMINIUM SHOVEL NR.9
ERGONOMIC ALUMINIUM HANDLE
PELLE ALUMINIUM POIGNÉE
D'ALUMINIUM ERGONOMIQUE



| Art. No. | (A x B) | | | i |
|----------|--------------|------|------|---|
| 766 787 | 390 x 380 AL | 1,70 | 1300 | - |

STRGALO 150, 300 & 500
STOBSCHARRE

SCRAPER
GRATOIR



| Art. No. | (A x B) | | | i |
|----------|-----------|------|------|----|
| 743 105 | 150 x 150 | 0,55 | - | NO |
| 759 760 | 150 x 150 | 0,55 | - | NO |
| 743 106 | 300 x 150 | 0,90 | - | NO |
| 759 761 | 300 x 150 | 0,90 | - | NO |
| 758 184 | 300 x 150 | 1,00 | - | OJ |
| 764 027 | 300 x 150 | 1,00 | - | OJ |
| 743 107 | 500 x 150 | 1,60 | - | OJ |
| 759 762 | 500 x 150 | 1,60 | - | OJ |
| 758 939 | 150 x 150 | 1,15 | 1300 | NO |
| 758 940 | 300 x 150 | 1,50 | 1300 | NO |
| 758 941 | 300 x 150 | 1,60 | 1300 | OJ |
| 758 942 | 500 x 150 | 2,00 | 1300 | OJ |

LOPATA SNEŽNA PONVASTA Z
Z ALUMINIJASTIM ERGONOMSKIM
ROČAJEM
SCHNEESCHAUFEL MIT
ERGONOMISCHEM ALU STIEL

SNOW SHOVEL WITH
ERGONOMIC ALUMINIUM HANDLE
PELLES A NEIGE
POIGNÉE D'ALUMINIUM
ERGONOMIQUE



| Art. No. | (A x B) | | | i |
|----------|-----------|------|------|---|
| 765092 | 410 x 310 | 1,75 | 1250 | - |

STRGALO ZA LED
STOBSCHARRE

ICE SCRAPER
GRATOIR



| Art. No. | (A x B) | | | i |
|----------|-----------|------|------|---|
| 716 104 | 140 x 100 | 0,60 | - | - |
| 721 930 | 140 x 100 | 1,15 | 1100 | - |

STRGALO 200
STOBSCHARRE 200

FLOOR CSRAPER 200
GRATTOIR 200



| Art. No. | (A x B) | | | i |
|----------|----------|------|------|---|
| 759 693 | 203 x 76 | 0,45 | - | - |
| 756 335 | 203 x 76 | 1,50 | 1320 | - |

STRGALO 140 & 300
EISSTÖBER

ICE SCRAPER
GRATOIR



| Art. No. | (A x B) | | | i |
|----------|-----------|------|------|---|
| 757 092 | 140 x 120 | 0,60 | - | - |
| 758 952 | 300 x 120 | 1,25 | - | - |
| 759 764 | 140 x 120 | 1,55 | 1300 | - |
| 759 765 | 300 x 120 | 2,20 | 1300 | - |

**NABIJAČ
STAMPFER** **POST RAMMER
DAME RONDE**



| Art. No. | (A x B) | | | |
|----------|------------|------|---|---|
| 757 936 | ø140 x 660 | 14,8 | - | - |
| 757 937 | ø165 x 660 | 18,0 | - | - |

**NABIJALEC BETONA
BETONSTAMPFER** **CONCRETE HAMMER
DAME DE CARRECEUR**



| Art. No. | (A x B x C) | | | | <i>i</i> |
|----------|-----------------|-------|---|---|----------|
| 759 575 | 150 x 150 x 840 | 8,25 | - | - | - |
| 764 235 | 170 x 170 x 840 | 5,10 | - | - | - |
| 758 966 | 200 x 200 x 840 | 12,15 | - | - | - |
| 765 754 | 200 x 200 x 840 | 12,25 | - | - | - |

**OKOVJE
SCHIENENZWINGE, BÜCHSE** **FERRULE
FERULE ET CAPUCHON**



| Art. No. | | | | | <i>i</i> |
|----------|---------|------|---|-------|----------|
| 757332 | L = 230 | 0,11 | - | ø23,8 | - |
| 763016 | L = 85 | 0,05 | - | ø23,8 | - |

**TLAČILEC SMETI
ABFALLPRESSE** **WASTE COMPACTOR
COMPACTEUR DE DÉCHETS**



| Art. No. | | | | | <i>i</i> |
|----------|------------------|-----|---|---|----------|
| 766679 | 300 x 200 x 1000 | 3,4 | - | - | - |

Profesionalno orodje Made in Slovenia

Tradicija kovaštva od leta 1573
Visokokvalitetni kovani in kaljeni proizvodi
Visokokvalitetni jesenovi lakirani ročajji
5 let garancije

Profiwerkzeuge Made in Slovenia

Schmiedetradition seit 1573
Hochwertige Schmiedeprodukte
Hochwertige Stiele aus lackiertem Eschenholz
5 Jahre Garantie

Professional tools Made in Slovenia

Tradition since 1573
High-quality forged and hardened products
High-quality lacquered ash handles
5 years guarantee





IZDELAVA ORODIJ NA CNC
OBDELOVALNIH CENTRIH

WERKZEUGHERSTELLUNG IN
CNC-BEARBEITUNGSZENTREN

PRODUCTION OF TOOLS ON
CNC MACHINING CENTRES

IZDELAVA ORODIJ NA CNC OBDELOVALNIH CENTRIH

Ponujamo izdelavo orodij za:

- Utopno kovanje
- Upogibanje
- Globoki vlek
- Odrezovanje
- Oblikovanje pločevine

WERKZEUGHERSTELLUNG IN CNC-BEARBEITUNGSZENTREN

Wir stellen Werkzeug für folgende Fertigungsverfahren her:

- Gesenshmieden und Freiform-
schmieden
- Biegen
- Tiefziehen
- Stanzen
- Blecbearbeitung

PRODUCTION OF TOOLS ON CNC MACHINING CENTRES

We offer production of tools for:

- Sink forging
- Banding
- Deep traction
- Stamping
- Formation of sheets

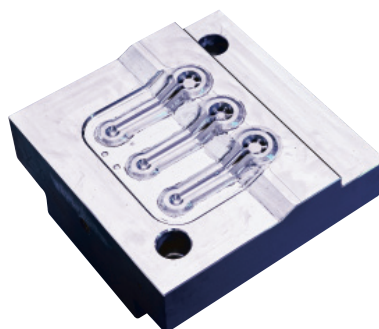
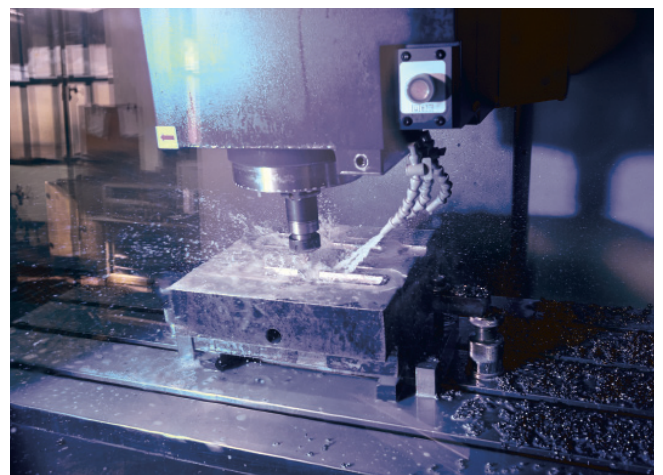

Izvajamo 2D in 3D rezkanje in ostale postopke odrezovanja kovin vključno z elektro erozijo.

Wir führen 2D und 3D Fräsarbeiten und andere Metallschneidverfahren samt Elektroerosion durch.

We perform 2D and 3D Milling and other cutting processes including electrical discharge machining.

Maksimalni pomiki obdelovalne glave:

Maximaler Verfahrenweg des Bearbeitungskopfes:

Maximum machine head feed:

x - 1050 mm

y - 570 mm

z - 510 mm

Maximalne mere obdelovanca:

Maximale Größe der Werkstücke:

Maximum dimensions of the working material:

900x450x350 mm (dxšxv)

Maximalna teža obdelovanca:

Maximales Werkstückgewicht:

Maximum mass of the working material:

900 kg



Orodjarna je opremljena z moderno CAD/CAM opremo ter sodobnimi obdelovalnimi stroji, ki omogočajo hitro in predvsem kvalitetno izdelavo orodij.

Unsere Werkzeugbauhalle ist mit modernster CAD/CAM-Ausrüstung und modernen Werkzeugmaschinen ausgestattet, die eine schnelle und hochwertigere Produktion ermöglichen.

Our tool production facility is equipped with modern CAD/CAM equipment and modern machine tools, which enable a quick and high-quality production of tools.

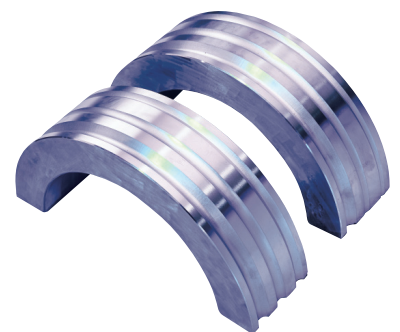
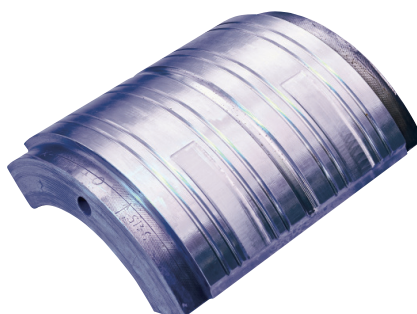
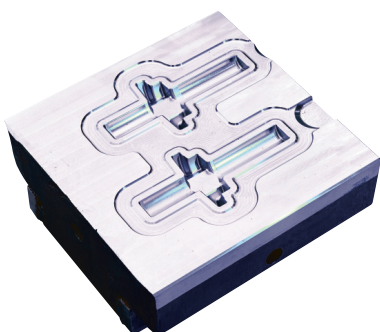

IZDELAVO ORODIJ PREPUSTITE STROKOVNJAKOM. SPREMLJAMO VAS OD NAČRTOVANJA DO IZDELAVE ORODIJ. IZKUŠNJE, NATANČNOST IN KRATKI ROKI IZDELAVE SO NAŠE GLAVNE PREDNOSTI.

ÜBERLASSEN SIE DIE WERKZEUGHERSTELLUNG ERFAHRENEN EXPERTEN. WIR BEGLEITEN SIE VON DER PLANUNG BIS ZUR FERTIGSTELLUNG DER WERKZEUGE.

LANGJÄHRIGE ERFAHRUNG, PRÄZISION UND KURZE PRODUKTIONS ZEITEN SIND UNSERE WESENTLICHEN VORTEILE.

MAKING TOOLS LET EXPERTS DO. WE FOLLOW YOU FROM PLANNING TO MANUFACTURING OF THE TOOLS. EXPERIENCES, ACCURACY AND SHORT DEADLINES ARE OUR MAIN ADVANTAGES.



AVTOMATIZACIJA VARJENJA

SCHWEIßAUTOMATISIERUNG

AUTOMATED WELDING



IZDELAVA ETIKET

PRODUKTION VON ETIKETTEN

PRODUCTION OF LABELS

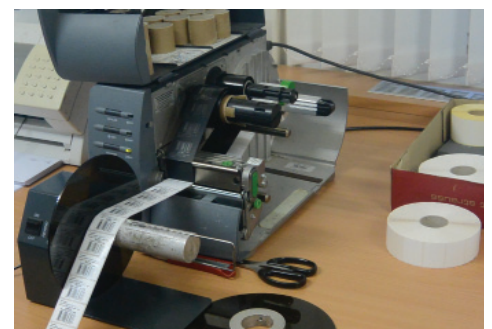

ODKOVKI IN PLOČEVINASTI DELI
SCHMIEDE- UND BLECHTEILE
FORGINGS AND SHEET METAL PRODUCTS



Podjetje izvaja tudi sledeče storitve:

- utopno kovanje – odkovki teže med 0,5 kg in 6 kg
ter dolžine do 350 mm
- izsekovanje
- upogibanje
- globoki vlek
- žarjenje
- kaljenje
- popuščanje
- cementiranje
- peskanje
- izdelava orodij

In unserem Schmiedebetrieb haben wir folgende Bearbeitungsmöglichkeiten:

- Gesenkschmieden und Freiformschmieden –
Schmiedeteile von 0,5 kg bis 6 kg und Abmessungen
bis cca. 350 mm
- Stanzen
- Biegen
- Tiefziehen
- Glühen
- Härten
- Anlassen
- Zementieren
- Sandstrahlen
- Werkzeugbau

In our company the following services are performed:

- sink forging – forgings from 0,5 kg – 6 kg and
dimension up to 350 mm
- stamping
- bending
- deep traction
- incandescing
- hardening
- tempering
- cementation
- sandblasting
- tool construction and production

STRUC Kovačija Muta

www.struc.info

Na spletni stani www.struc.info si lahko ogledate širok program naših izdelkov.

Auf www.struc.info finden Sie umfangreiche Informationen über unsere Produkte.

Have a look at www.struc.info to see our wide range of products.

STRUC



- STRUC Kovačija Muta d.o.o.
www.struckovacija.si
- STRUC MUTA, kmetijska mehanizacija d.o.o.
- STRUC Ekoing d.o.o.
www.struc.info
- Adolf Struc nepremičnine d.o.o.
nepremicnine.struc.info



STRUC Kovačija Muta d.o.o.
Tel. h.c.: +386 (0)2 8723-903
Fax: +386 (0)2 8723-904
E-Mail: kovacija@struc.info
www.struc.info

Spletna trgovina:

www.struckovacija.si

